



ORTHOPAEDIC
JOINT REPLACEMENT

AESCULAP® Plasmafit®

CEMENTLESS ACETABULAR CUP SYSTEM

AESFULAP[®] Plasmafit[®]

CEMENTLESS ACETABULAR CUP SYSTEM

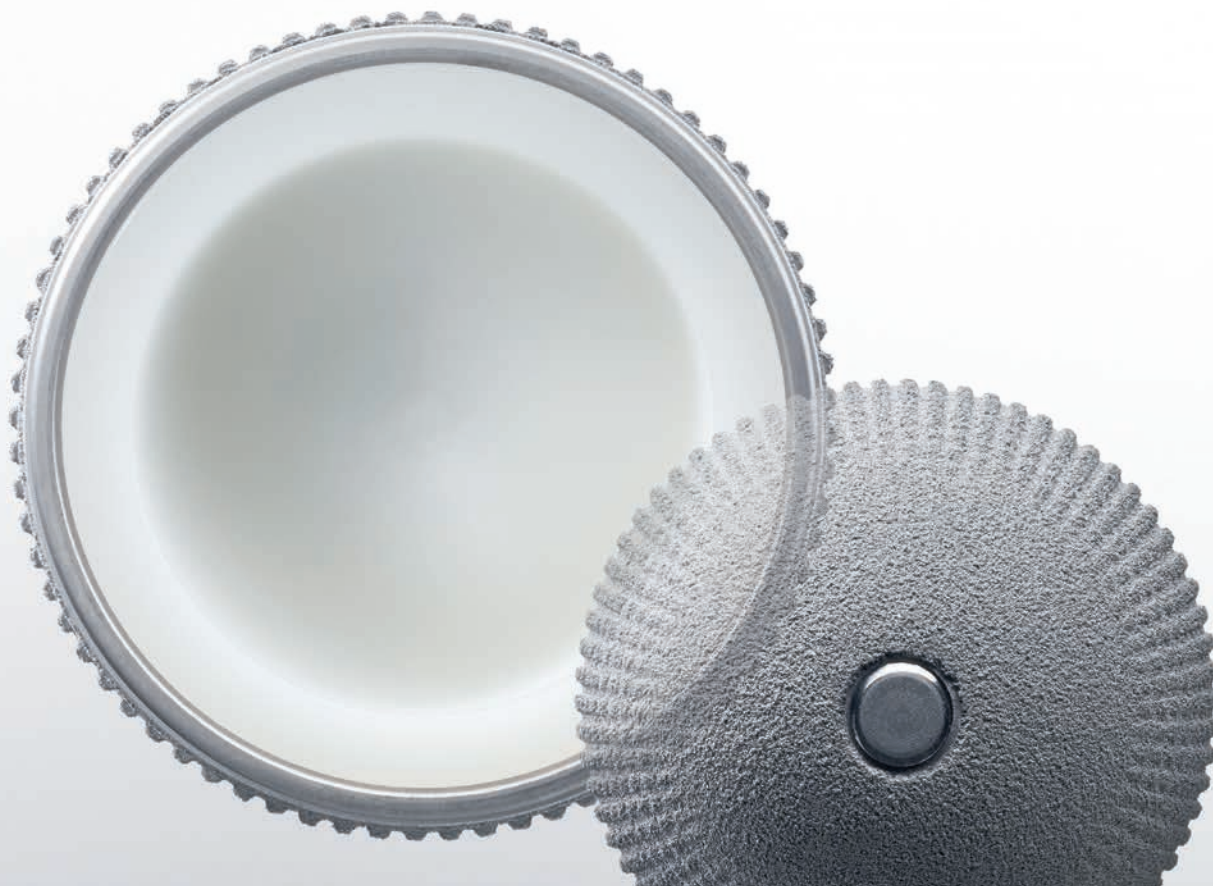



CONTENT

1	CONCEPT	4
2	SYSTEM	6
3	SURFACE	8
4	DESIGN	10
5	ARTICULATION	12
6	SURGICAL TECHNIQUE	14
7	IMPLANTS	18
8	INSTRUMENTS	24

AESCULAP® Plasmafit®

1 | CONCEPT



Ream the Fit

- ✓ NO TRIAL CUPS

The precise profile structure of the Plasmafit® surface enables the surgeon to skip the step of trial cup implantation in most cases.



Feel the Fit

- ✓ NO SCREWS

The intraoperative primary stability of Plasmafit® reduces the need for additional screw fixation to only a few cases and allows implantations with screws under challenging conditions and easy revision treatments.



Fit the Insert

- ✓ NO COMPROMISES

The wall thickness of both Plasmafit® implant lines offers an improved articulation choice for highly crosslinked polyethylene and ceramic cup liners.

FEEL THE GRIP.
GET THE FIT.

Plasmafit® Poly

IMPROVED CUP IMPLANT LINE FOR Vitelene® XLPE

- ✓ Thin metal shell without screw option
- ✓ Only for polyethylene liners
- ✓ Large articulation diameter for small cup sizes
- ✓ 36 mm articulation for cup size 50 and higher
- ✓ PE wall thickness of min. 5.5 mm in main load area
- ✓ Closing plug for central insertion hole



Plasmafit® Plus

UNIVERSAL CUP IMPLANT LINE FOR CERAMIC AND POLYETHYLENE WITH SCREW OPTION

- ✓ Thick cup design with screw option
- ✓ For the use of ceramic and polyethylene cup liners
- ✓ Biolox® delta, Vitelene® and conventional PE
- ✓ 36 mm articulation for cup size 52
- ✓ Cup alternatives with no, 3 or 7 screw holes
- ✓ Closing plug for no hole cup line

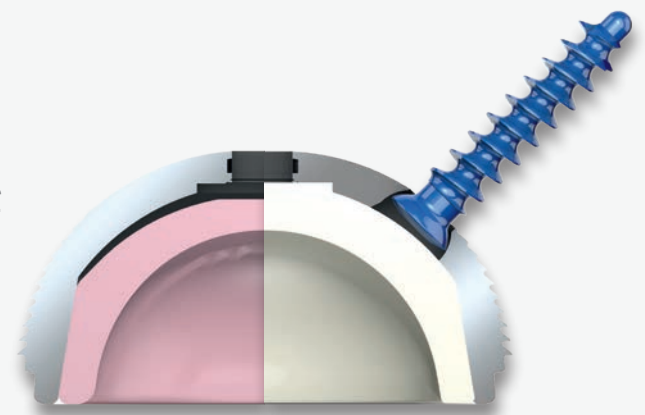

Plasmafit® PLUS
without screw hole



Plasmafit® PLUS 3
with 3 screw holes



Plasmafit® PLUS 7
5 screw holes cranially, 2 screw holes caudally



AESCULAP® Plasmafit®

2 | SYSTEM

Plasmafit® Poly with Vitelene®

- ✓ Thin shell without screw holes
- ✓ Increased polyethylene wall thickness
- ✓ Large articulation diameter

Plasmafit® Poly is a dedicated cup implant line exclusively for the use with polyethylene liners. The profile of the wall thickness enlarges the material thickness of polyethylene liners and allows the optional use of correction liners.

Plasmafit® Poly implants enable a 36 mm highly crosslinked Vitelene® liner for cup size 50, up to a 40 mm articulation for cup size 54.

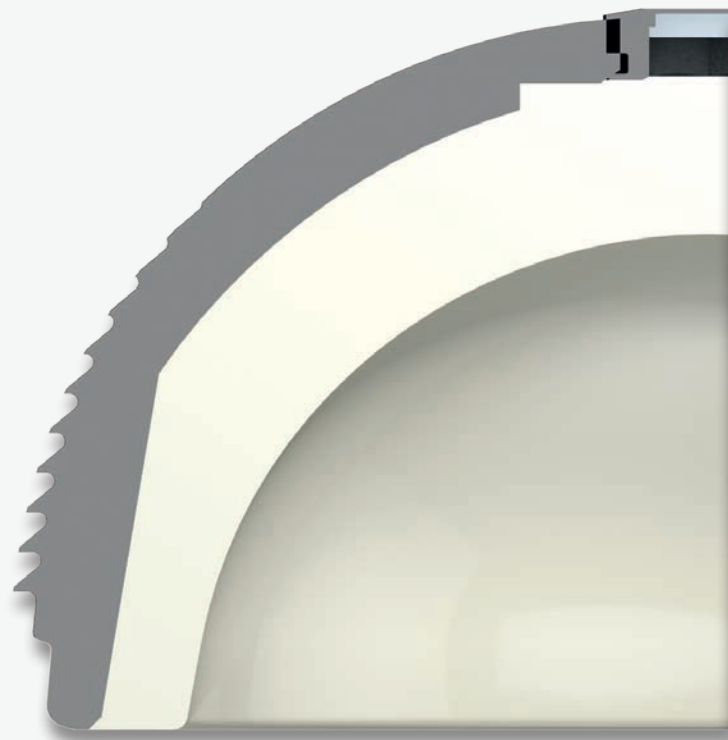

Plasmafit® Poly from size 50 with 36 mm Vitelene®

Plasmafit® POLY AND Plasmafit® PLUS

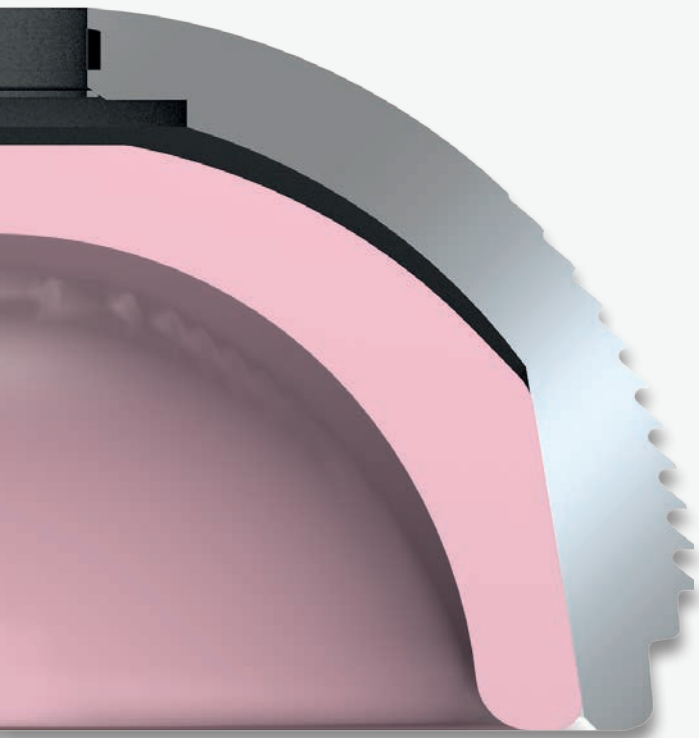

Plasmafit® Plus from size 52 with 36 mm BioloX® delta

Plasmafit® Plus with BioloX® delta

- ✓ Universal cup implant line
- ✓ Vitelene® as additional bearing option
- ✓ Implants with and without cancellous screws

Plasmafit® Plus designed for combined treatments with ceramic or polyethylene articulation materials.

The increased wall thickness compared to Plasmafit® Poly allows additional screw holes for an optional use of cancellous fixation screws.

A 36 mm BioloX® delta ceramic on ceramic articulation can be realized for cup size 52, 40 mm articulation for cup size 56.

All Plasmafit® Plus cup implants can be combined with modular Vitelene® polyethylene liners made of vitamin E stabilized highly crosslinked polyethylene.

AESCULAP® Plasmafit®

3 | SURFACE

- ✓ High implant stability
- ✓ Wide range of indication
- ✓ Easy surgical technique

Plasmafit® Structure

The profile structure of the Plasmafit® cup surface features a precise and fine tooth geometry which gradually diminishes towards the dome.

The primary implant stability should be supported particularly on the rim of the cup.

The pressfit locking allows a primary cup stability under different bone qualities and cup preparations.



**HIGH IMPLANT
STABILITY**

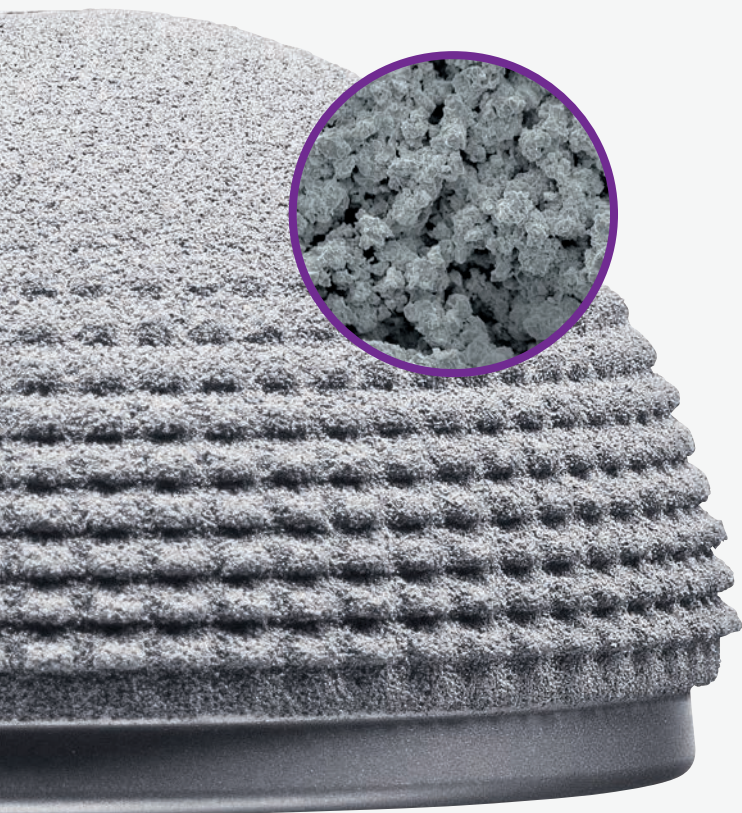

- ✓ Microporous pure titanium coating
- ✓ Increased implant surface
- ✓ Pressfit locking in implant bed

Plasmapore® Coating

The combination of the Plasmafit® surface structure with the Plasmapore® coating leads to a very rough implant surface. Pure titanium powder is applied in a plasma vacuum coating process to the surface of cementless implants to form a 0.35 mm thick layer with up to 50% porosity.

The Plasmapore® surface supports the direct bone apposition on the increased implant surface.

AESCULAP® Plasmafit®

4 | DESIGN

Plasmafit® Periphery

The external Plasmafit® shape is spherical with a slightly flattened dome. The centre of rotation with standard liners is located on the exact cup entrance plane. The liners are supported by the rounded rim of the cup. The equatorial pressfit is 1.5 mm.

Plasmafit® Structure

The design of the Plasmafit® inside allows an intraoperative choice of modular liners, alternatively polyethylene or ceramic.

Plasmafit® Plus cups can be combined with liners of polyethylene, ceramic and fixation screws. The thin-walled implant line Plasmafit® Poly is especially designed for polyethylene liners.

The fixation of the Plasmafit® liners is realized by a large area conical locking mechanism. Polyethylene liners have an additional locking-free contact with the base of the cup.

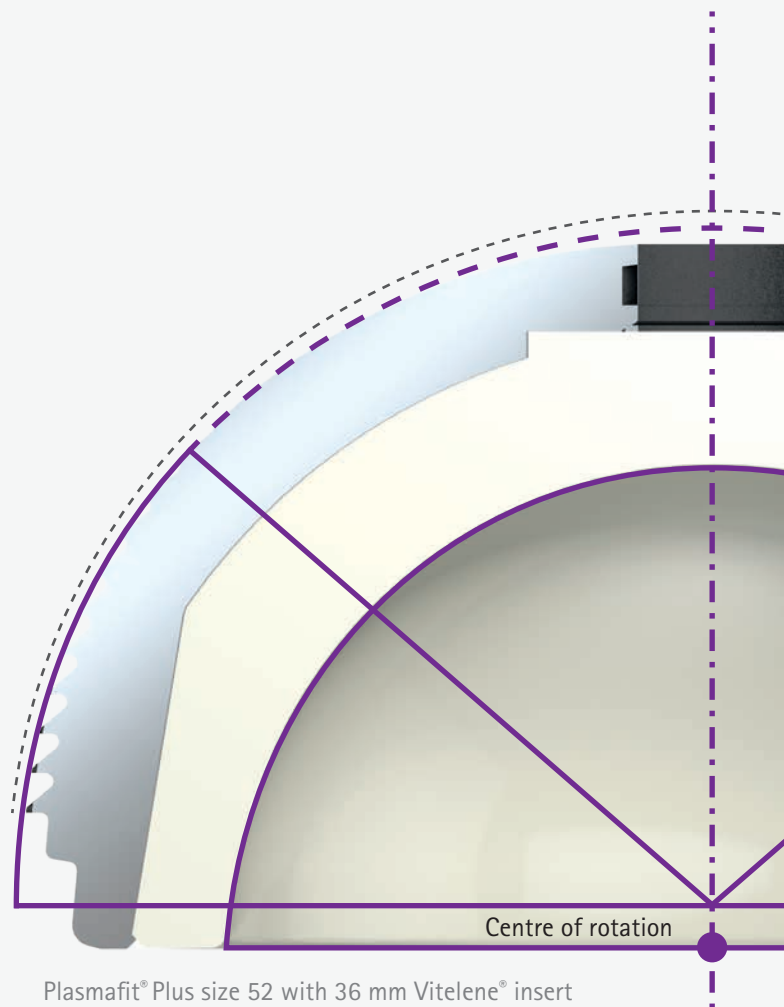

CONICAL LOCKING MECHANISM

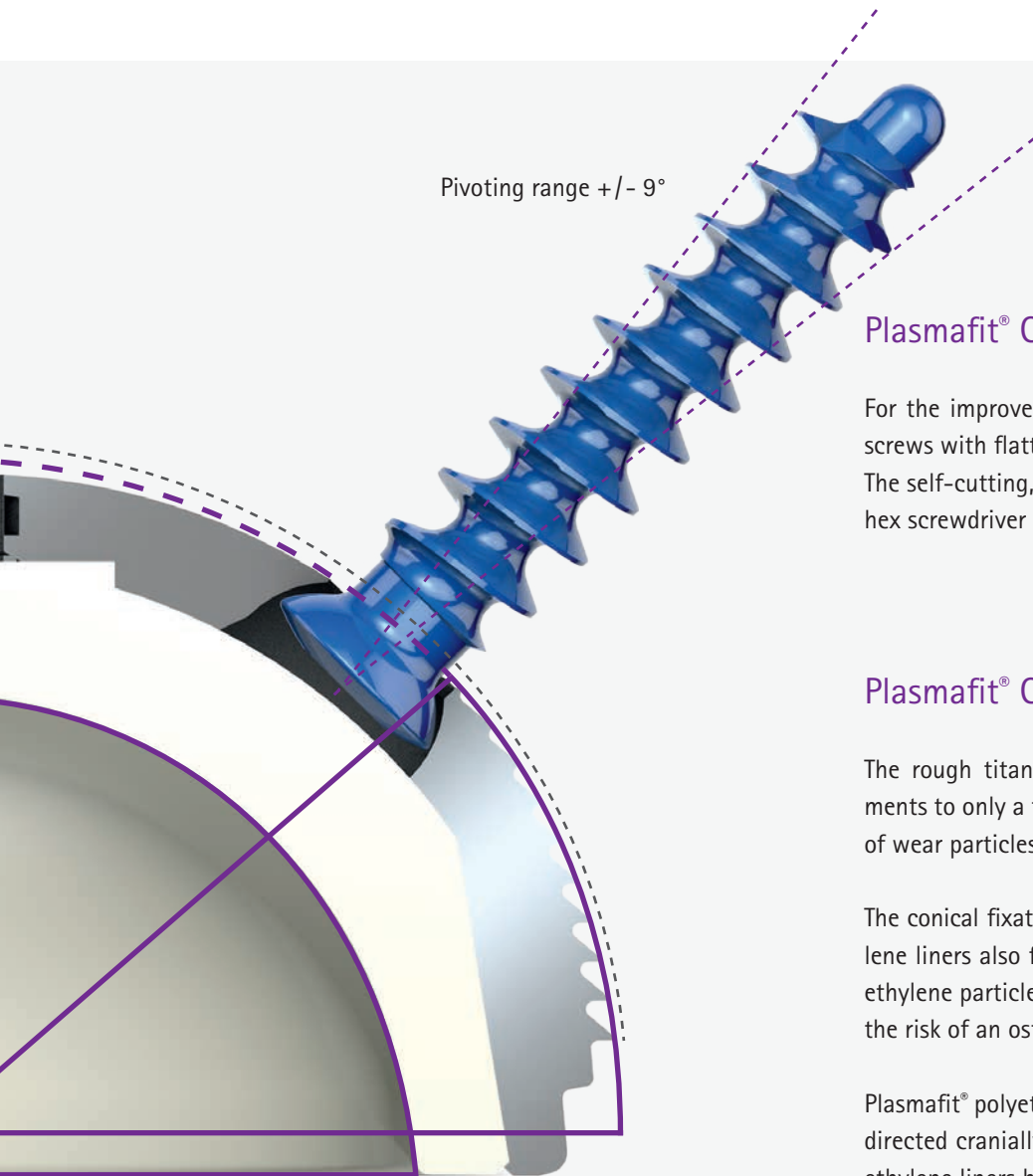

Pivoting range +/- 9°

Plasmafit® Cancellous Screws

For the improved Plasmafit® wall thickness special fixation screws with flatter screw heads have been designed. The self-cutting, blue 6.5 mm screws are inserted with a 3.5 hex screwdriver and allow a pivoting angle of +/- 9°.

Plasmafit® Coating

The rough titanium inner surface reduces relative movements to only a few microns, thus preventing the formation of wear particles on the rear side of the liner.

The conical fixation surface area of the Plasmafit® polyethylene liners also forms a seal against the migration of polyethylene particles from the articulating joint, thus reducing the risk of an osteolysis adjacent to the screw holes.

Plasmafit® polyethylene liners are strongest when the load is directed cranially. In the primary load area Plasmafit® polyethylene liners have a minimum thickness of 5.5 mm. The fixation has a high stability against tilting and rotation forces in vivo.

Source: Aesculap AG, Tuttlingen, Internal Lab Tests 2011 / 2012.

AESCULAP® Plasmafit®

5 | ARTICULATION

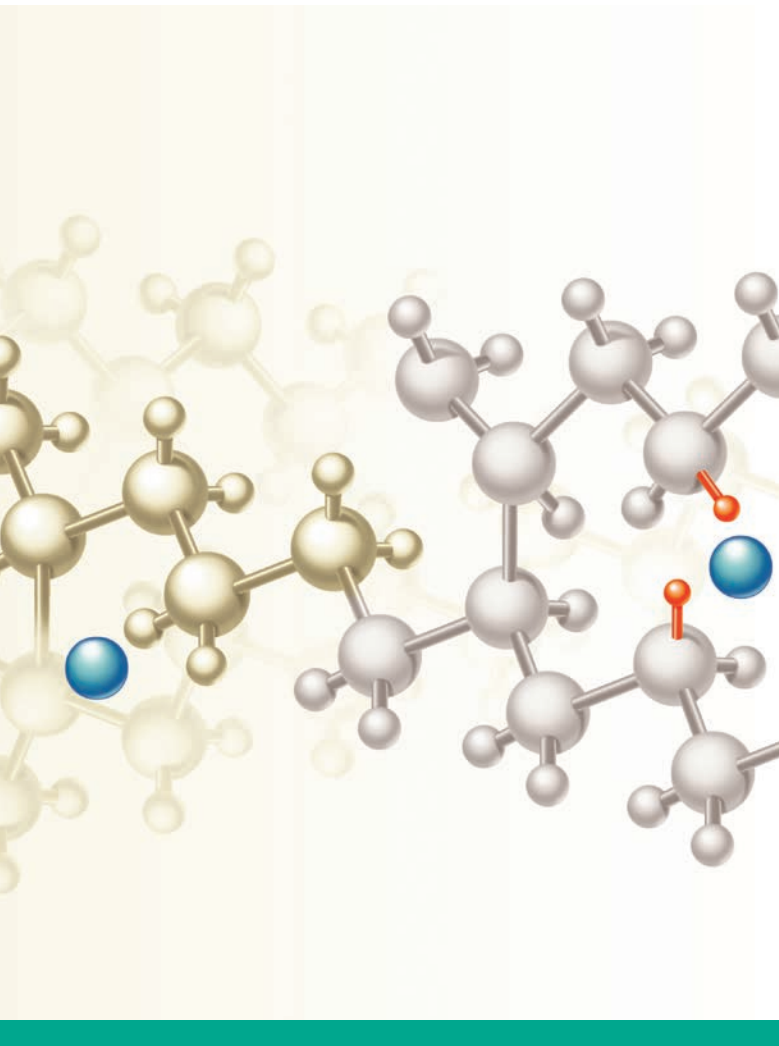

Vitelene® for Plasmafit® Poly

Vitelene® is a highly crosslinked polyethylene stabilized with vitamin E. Vitamin E provides long-term oxidation protection by binding free radicals through the release of H atoms. Polyethylene powder GUR 1020 is mixed with vitamin E (0.1% α -Tocopherol) and pressed into sheets. Afterwards a total dose of 80 kGy electron beam radiation is applied to cross link the blank product. The Vitelene® inserts are manufactured using state of the art CNC technology and sterilized with ethylene oxide. There is no post-irradiation thermal treatment necessary, hence no negative impact on mechanical properties is induced. Vitelene® needs no thermal treatment and has, therefore, balanced mechanical properties.

It is characterized by wear and oxidation resistance. The in vitro wear of Plasmafit® Vitelene® liners in combination with a 36 mm ceramic head is three times below the threshold that is known to cause osteolysis. Higher wear rates can occur with metal heads, by third-body wear, through cup malpositioning or as a result of implant loosening.

Oxidation index

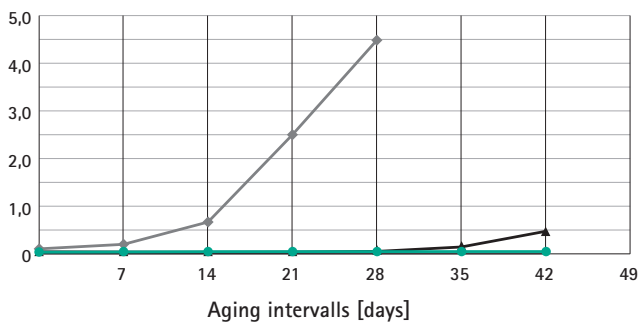

- PE konventionell
- XLPE Standard
- Vitelene

Oxidation index measurements of conventional, standard highly crosslinked polyethylene and vitamin E stabilized highly crosslinked Vitelene®.

Source: Grupp T et al. Biotribology of a vitamin E-stabilized polyethylene for hip arthroplasty – Influence of artificial ageing and third-body particles on wear. Acta Biomaterialia. 2014 Jul;10(7):3068–78. Epub 2014 Mar 12.



BioloX® delta for Plasmafit® Plus

When using ceramic BioloX® delta cup liners wear particles in the joint are reduced to only a few μm per year. With a correct implant positioning and a good joint stability a ceramic on ceramic total hip arthroplasty is approved.

Source: CeramTec GmbH, Plochingen.

BioloX® delta is a high strength aluminium oxide matrix ceramic. Besides high fracture strength BioloX® delta implant components are characterized additionally by high fracture toughness. Finest ZrO_2 particles strengthen the ceramic material and prevent the propagation of cracks. This leads to an excellent material strength. For the Plasmafit® Plus implant line newly developed BioloX® delta ceramic liners are available. During the development process, special attention was paid to rounded liner edges, maximum liner wall thickness and conical fixation area.

Source: CeramTec GmbH, Plochingen.

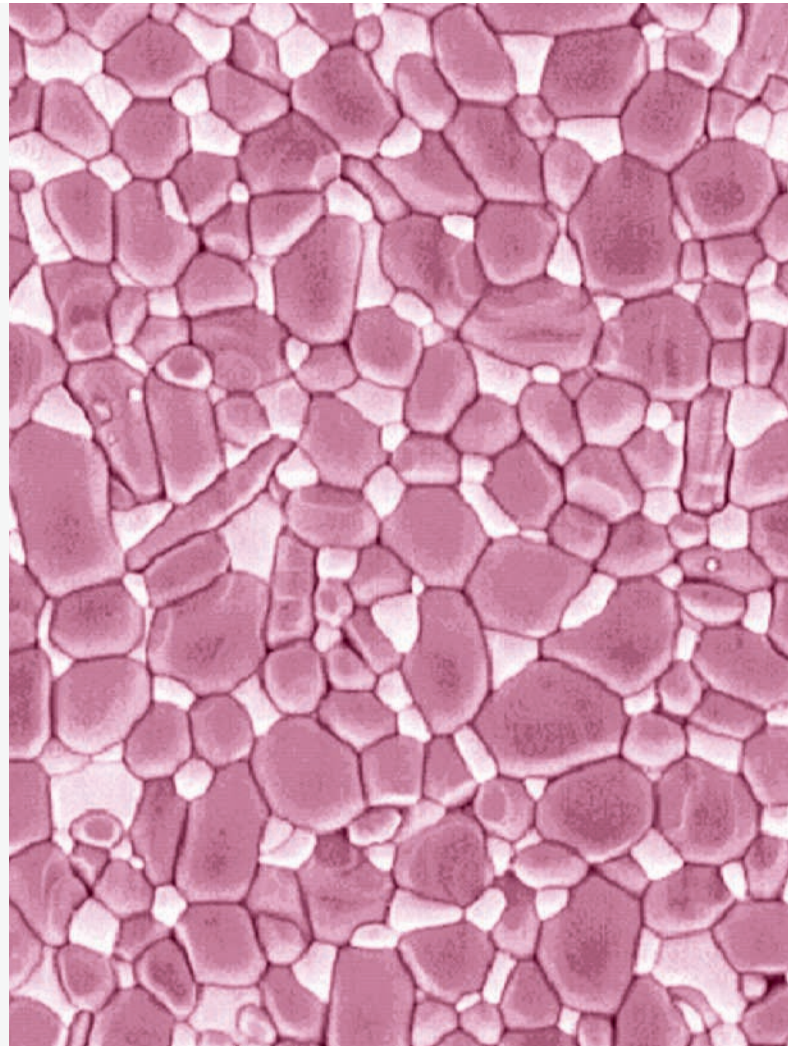

Gravimetric wear [mg/million]

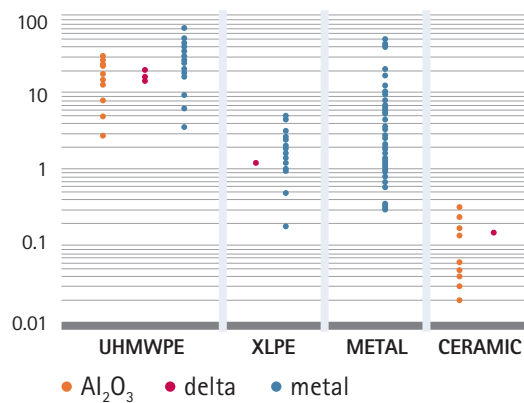

ISO 14242 hip simulator wear measurements and data referring to other studies.

Source: Dr. Ing. Christian Kaddick, Endolab Mechanical Engineering GmbH, Thansau/Rosenheim.

AESCULAP® Plasmafit®

6 | SURGICAL TECHNIQUE



Acetabular preparation

Acetabular exposure and removal of cartilage and osteophytes are required for the proper preparation of the acetabulum. This is done by using spherical reamers, which are driven by a low-speed motor handpiece. During the reaming procedure all cartilage down to the subchondral bone must be ablated until bleeding occurs.

For non-dysplastic cases care must be taken not to medialize the center of rotation of the joint unnecessarily. The rim of the acetabulum should be prepared for a sufficient large bony fixation surface.

In cases of dysplastic changes a cup position in the region of the primary socket is recommended, as far as a shortening of the leg can be compensated. The caudal edge of the shell should be at the level of the tear drop figure. If necessary, a cranial bone graft, to provide sufficient cranial roofing, is positioned before the socket base is prepared.



Trial cup insertion

The size of the Plasmafit® implant corresponds to the size of the last acetabular reamer and includes the proper pressfit conditions.

In difficult bone conditions, the use of a trial cup is recommended prior to the final cup implant selection. A stable fit of this trial cup is achieved when the pelvis of the patient can be moved slightly by gently moving the cup impactor. The trial implant can be easily levered out from the in-vivo trial position by moving beyond this angle.

For the implantation of the Plasmafit® cup implants two straight insertion instruments with two different lengths and one curved instrument for less invasive surgical approaches are provided.

CEMENTLESS ACETABULAR CUP SYSTEM

The accurate and stable assembly of the Plasmafit® implant on the insertion instrument must be checked by a surgical assistant and the surgeon prior to the implantation. The impactor is also suitable for shifting and correcting the position of the cup implant. For the positioning of the cup implant aiming devices are available either for supine or lateral patient position. Additionally a universal aiming device for both patient positions can be offered, where inclination and anteversion can also be adjusted in 5° steps.

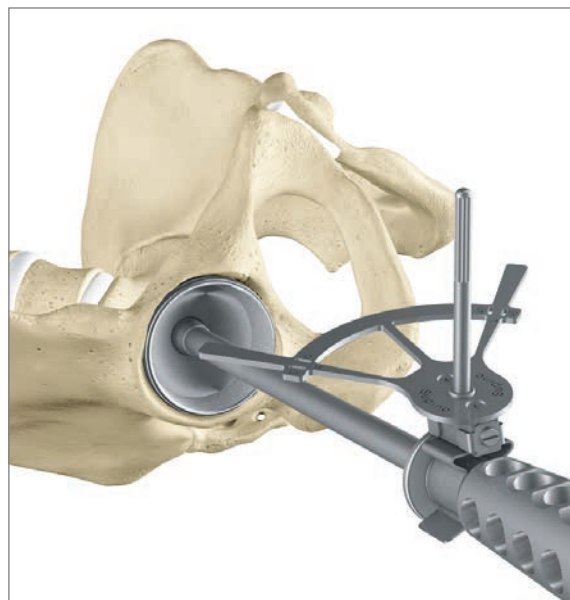

Plasmafit® cup implants can be navigated with all OrthoPilot® Hip Suite software applications. The Plasmafit® instruments are designed for use with navigation technology and can be combined with all specific navigation instruments.

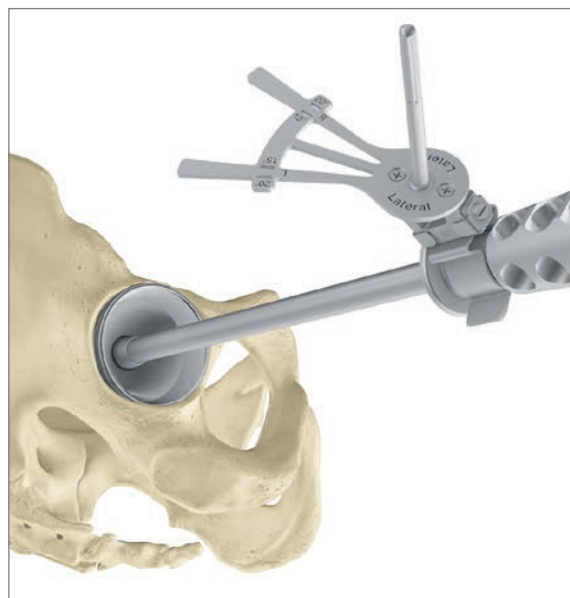

AESCULAP® Plasmafit®

6 | SURGICAL TECHNIQUE



Plasmafit® cup implant with central closing plug

After completing the surgical steps of acetabular exposure, reaming and implantation of the Plasmafit® cup, the central impactation hole can be closed with a plug which is automatically provided with the no hole cup implants.

Afterwards the insertion of the trial liner follows. The final selection of the modular liner is determined after the stem is implanted and a final trial reduction has been performed.



Plasmafit® with trial liner

Liners with posterior wall (hooded) increase luxation stability e.g. towards posterior for implantations using the posterior surgical approach. The asymmetrical liners correct the cup position by 10 degrees.

In good bone Plasmafit® can be implanted without additional screws. As a stability check the cup impactor is moved slightly until the patient's pelvis moves. Under these conditions, Plasmafit® Plus 3 can also be rotated 180° prior to implantation, placing the screw holes in the non load bearing caudal region since they are not needed cranially.

CEMENTLESS ACETABULAR CUP SYSTEM

Plasmafit® Plus with additional screw fixation

If there is any doubt concerning the intraoperative primary stability the Plasmafit® Plus implant line can optionally be used with screws. Plasmafit® Plus 3 cup implants offer three screw holes in the cranial region. To protect the medial blood vessels, the middle and lateral screw positions can be used and the medial hole is usually left open. Plasmafit® 5 and 7 offer further screw holes in the cranial and caudal region.

Prior to inserting the self-tapping 6.5 mm screws the drill holes are prepared with a flexible 3.2 mm drill. The required screw length is measured and the screws are implanted using a screw holding forceps and a cardan screwdriver.



Plasmafit® Plus with Biolox® delta ceramic liner

The ceramic Plasmafit® liners can be removed with special attachments for the cup impactor. It is important to place the instruments precisely on the rim of the metal shell. The separation of the liner from the cup is done with several sharp blows or impulses. Please see the instructions for use enclosed with every Plasmafit® implant.

When using ceramic liners the final check for seating is assessed with a fingertip check. After inserting, the liner is fixed using an impactor with a plastic head. After the joint reduction the correct liner position should be checked again.





Removal of ceramic cup liners



AESCULAP® Plasmafit®

7 | IMPLANTS

Plasmafit® Poly Implants

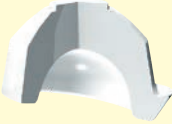
Cup size		40	42	44	46	48	50
Liner size		B	C	D	E	F	G
Plasmafit® Poly	ISOTAN® _F	NV040T	NV042T	NV044T	NV046T	NV048T	NV050T
symmetrical Vitelene® 	ø 22.2 mm	NV183E	NV184E	-	-	-	-
	ø 28 mm	-	NV189E	NV190E	NV191E	NV192E	NV193E
	ø 32 mm	-	-	-	NV201E	NV202E	NV203E
	ø 36 mm	-	-	-	-	-	NV213E
	ø 40 mm	-	-	-	-	-	-
posterior wall Vitelene® 	ø 22.2 mm	NV283E	NV284E	-	-	-	-
	ø 28 mm	-	NV289E	NV290E	NV291E	NV292E	NV293E
	ø 32 mm	-	-	-	NV301E	NV302E	NV303E
	ø 36 mm	-	-	-	-	-	NV313E
asymmetrical Vitelene® 	ø 22.2 mm	NV383E	NV384E	-	-	-	-
	ø 28 mm	-	NV389E	NV390E	NV391E	-	-
	ø 32 mm	-	-	-	NV401E	NV402E	NV403E
symmetrical UHMWPE	ø 32 mm	-	-	-	NV201	NV202	NV203
with shoulder UHMWPE	ø 28 mm	-	NV289	NV290	-	-	-
	ø 32 mm	-	-	-	NV301	NV302	NV303

52	54	56	58	60	62
H	I	J	K	L	M
NV052T	NV054T	NV056T	NV058T	NV060T	NV062T
-	-	-	-	-	-
NV194E	NV195E	-	-	-	-
NV204E	NV205E	NV206E	NV207E	NV208E	NV209E
NV214E	NV215E	NV216E	NV217E	NV218E	NV219E
-	NV225E	NV226E	NV227E	NV228E	NV229E
-	-	-	-	-	-
NV294E	NV295E	-	-	-	-
NV304E	NV305E	NV306E	NV307E	NV308E	NV309E
NV314E	NV315E	NV316E	NV317E	NV318E	NV319E
-	-	-	-	-	-
-	-	-	-	-	-
NV404E	NV405E	NV406E	NV407E	NV408E	NV409E
NV204	NV205	NV206	NV207	NV208	NV209
-	-	-	-	-	-
NV304	NV305	NV306	NV307	NV308	NV309



Plasmafit® Poly
no screw holes, with closing plug







The central closing plug is automatically delivered with cup implants without screw holes.

The closing plug NV001T can also be ordered separately.

AESCULAP® Plasmafit®

7 | IMPLANTS

Plasmafit® Plus Implants

Cup size		40	42	44	46	48	50	52
Liner size		A	B	C	D	E	F	G
Plasmafit® Plus	ISOTAN® _F	NV140T	NV142T	NV144T	NV146T	NV148T	NV150T	NV152T
Plasmafit® Plus 3	ISOTAN® _F	NV240T	NV242T	NV244T	NV246T	NV248T	NV250T	NV252T
Plasmafit® Plus 7	ISOTAN® _F	NV340T*	NV342T*	NV344T*	NV346T	NV348T	NV350T	NV352T
		* with 5 screw holes						
symmetrical Biolox® delta 	ø 28 mm	-	-	NV089D	NV090D	NV091D	NV092D	NV093D
	ø 32 mm	-	-	-	-	NV101D	NV102D	NV103D
	ø 36 mm	-	-	-	-	-	-	NV113D
	ø 40 mm	-	-	-	-	-	-	-
symmetrical Vitelene® 	ø 22.2 mm	NV182E	NV183E	NV184E	-	-	-	-
	ø 28 mm	-	-	NV189E	NV190E	NV191E	NV192E	NV193E
	ø 32 mm	-	-	-	-	NV201E	NV202E	NV203E
	ø 36 mm	-	-	-	-	-	-	NV213E
	ø 40 mm	-	-	-	-	-	-	-
posterior wall Vitelene® 	ø 22.2 mm	NV282E	NV283E	NV284E	-	-	-	-
	ø 28 mm	-	-	NV289E	NV290E	NV291E	NV292E	NV293E
	ø 32 mm	-	-	-	-	NV301E	NV302E	NV303E
	ø 36 mm	-	-	-	-	-	-	NV313E
asymmetrical Vitelene® 	ø 22.2 mm	NV382E	NV383E	NV384E	-	-	-	-
	ø 28 mm	-	-	NV389E	NV390E	NV391E	-	-
	ø 32 mm	-	-	-	-	NV401E	NV402E	NV403E
symmetrical UHMWPE	ø 32 mm	-	-	-	-	NV201	NV202	NV203
with shoulder UHMWPE	ø 28 mm	-	-	NV289	NV290	-	-	-
	ø 32 mm	-	-	-	-	NV301	NV302	NV303

54	56	58	60	62	64	66	68	70
H	I	J	J	J	K	K	K	K
NV154T	NV156T	NV158T	NV160T	NV162T	NV164T	NV166T	NV168T	NV170T
NV254T	NV256T	NV258T	NV260T	NV262T	NV264T	NV266T	NV268T	NV270T
NV354T	NV356T	NV358T	NV360T	NV362T	NV364T	NV366T	NV368T	NV370T

NV094D	-	-	-	-	-	-	-	-
NV104D	NV105D	NV106D	-	-	NV107D	-	-	-
NV114D	NV115D	NV116D	-	-	NV117D	-	-	-
-	NV125D	NV126D	-	-	NV127D	-	-	-

-	-	-	-	-	-	-	-	-
NV194E	NV195E	-	-	-	-	-	-	-
NV204E	NV205E	NV206E	-	-	NV207E	-	-	-
NV214E	NV215E	NV216E	-	-	NV217E	-	-	-
-	NV225E	NV226E	-	-	NV227E	-	-	-

-	-	-	-	-	-	-	-	-
NV294E	NV295E	-	-	-	-	-	-	-
NV304E	NV305E	NV306E	-	-	NV307E	-	-	-
NV314E	NV315E	NV316E	-	-	NV317E	-	-	-

-	-	-	-	-	-	-	-	-
-	-	-	-	-	-	-	-	-
NV404E	NV405E	NV406E	-	-	NV407E	-	-	-

NV204	NV205	NV206	-	-	NV207	-	-	-
-	-	-	-	-	-	-	-	-
NV304	NV305	NV306	-	-	NV307	-	-	-



Plasmafit® Plus
no screw holes, with closing plug



Plasmafit® Plus 3
with 3 screw holes



Plasmafit® Plus 7
5 screw holes cranially, 2 screw holes caudally



The central closing plug is automatically delivered with cup implants without screw holes.

The closing plug NV001T can also be ordered separately.

AESCULAP® Plasmafit®

7 | IMPLANTS

Ceramic – Prosthesis Heads



12/14

Diameter	Art. no.				
	ø 22.2 mm	ø 28 mm	ø 32 mm	ø 36 mm	ø 40 mm
S	-	NK460D	NK560D	NK650D	NK750D
M	-	NK461D	NK561D	NK651D	NK751D
L	-	NK462D	NK562D	NK652D	NK752D
XL	-	-	NK563D	NK653D	NK753D

BioloX® delta

Metal – Prosthesis Heads



12/14

Diameter	Art. no.				
	ø 22.2 mm	ø 28 mm	ø 32 mm	ø 36 mm	ø 40 mm
S	-	NK429K	NK529K	NK669K	NK769K
M	NK330K	NK430K	NK530K	NK670K	NK770K
L	NK331K	NK431K	NK531K	NK671K	NK771K
XL	-	NK432K	NK532K	NK672K	NK772K
XXL	-	NK433K	NK533K	NK673K	NK773K

ISODUR®_F

Implant Materials:

BioloX® delta	Aluminium oxide matrix ceramic (Al ₂ O ₃ /ZrO ₂ /ISO 6474-2)
ISOTAN® _F	Titanium forged alloy (Ti6Al4V/ISO 5832-3)
ISODUR® _F	Cobalt-chromium forged alloy (CoCrMo/ISO 5832-12)
Plasmapore®	Pure titanium (Ti/ISO 5832-2)
UHMWPE	Ultra high molecular weight polyethylene (ISO 5834-2)
Vitelene®	UHMWPE-XE vitamin E stabilized highly crosslinked polyethylene

Plasmafit® – Cancellous Screws

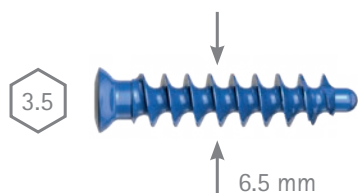

Length	Art. no.
16 mm	NV010T
20 mm	NV011T
24 mm	NV012T
28 mm	NV013T
32 mm	NV014T
36 mm	NV015T
40 mm	NV016T
44 mm	NV017T
48 mm	NV018T
52 mm	NV019T
56 mm	NV020T
60 mm	NV021T
64 mm	NV022T
68 mm	NV023T

ISOTAN®_F

AESFULAP® Plasmafit®

8 | INSTRUMENTS

Acetabular Reamer

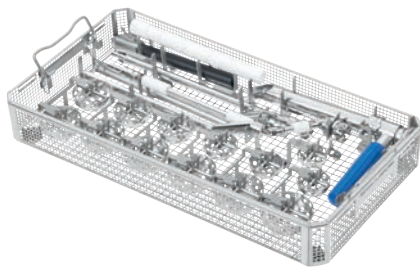

TRAY NF932R
485 x 253 x 76 mm

with supports for:	Art. no.
13 reamer heads, 2 straight and 1 curved reamer shank	
OrthoPilot® sleeve	FS939
Standard sleeve	FS974

Lid JH217R
489 x 257 mm
Packing stencil TE895

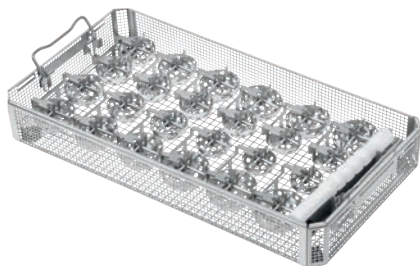

TRAY NF933R
485 x 253 x 76 mm

with supports for:	Art. no.
24 reamer heads and 2 straight reamer shanks	
OrthoPilot® sleeve	FS939
Standard sleeve	FS974

Lid JH217R
489 x 257 mm

Recommended container JK440
592 x 274 x 90 mm
Lid JK489

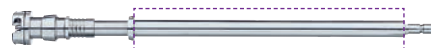

FS939 OR FS974

Straight reamer shanks, navigated	Art. no.
Reamer shank ZIMMER	FS959R
Reamer shank Harris	FS960R
Reamer shank AO	FS961R
OrthoPilot® sleeve	FS939
Standard sleeve	FS974



Curved reamer shanks	Art. no.
Reamer shank ZIMMER	NF935R
Reamer shank Harris	NF936R
Reamer shank AO	NF937R



FULL PROFILE REAMERS

Outer diameter	Art. no.
ø 38 mm	NF938R
ø 40 mm	NF940R
ø 42 mm	NF942R
ø 44 mm	NF944R
ø 46 mm	NF946R
ø 48 mm	NF948R
ø 50 mm	NF950R
ø 52 mm	NF952R
ø 54 mm	NF954R
ø 56 mm	NF956R
ø 58 mm	NF958R
ø 60 mm	NF960R
ø 62 mm	NF962R
ø 64 mm	NF964R
ø 66 mm	NF966R
ø 68 mm	NF968R

Reamer module	Art. no.
Half module tray with supports for reamers ø 44-68 mm, one straight reamer shank and protection sleeve 465 x 118 x 45 mm	NT635R

NOTE

Please order all reamer components separately.

NOTE

Acetabular reamer heads are also available with 1 mm increments on special request.

AESFULAP® Plasmafit®

8 | INSTRUMENTS

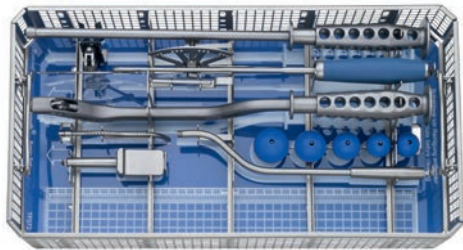

Plasmafit® BASIC SET NT400

Consisting of:	Art. no.
Tray with storage and space for one small and one half module tray 489 x 253 x 106 mm	NT401R
Lid	JH217R
Graphic template for NT400	TF072
Screwdriver SW 4.5	NT412R
Polyamid head ø 28 mm	FS979
Polyamid head ø 32 mm	FS980

Please order separately:	Art. no.
Insertion instrument length 442 mm	NT410R*
Insertion instrument short length 377 mm	NT414R*
Insertion instrument curved length 442 mm	NT411R
Plug insertion instrument curved	NT413R
Rotation and extraction plate	NT416R
Universal aiming device, adjustable	NT420R**
Aiming device supine position	NT417R**
Aiming device lateral position	NT418R**
Polyamid head ø 22.2 mm	FS977
Polyamid head ø 36 mm	FS983
Polyamid head ø 40 mm	FS988

* In the basic set NT400 one insertion instrument can be stored.

** In the basic set NT400 one aiming device can be stored.

Plasmafit® CERAMIC REMOVAL NT480

Consisting of:	Art. no.
Small tray can be clicked into the basic set 428 x 59 x 30 mm	NT481R
Universal articulation attachment	NT431R
Bar for size 44 mm C	NT471R
Bar for size 46 mm D	NT472R
Bar for size 48 mm E	NT473R
Bar for size 50 mm F	NT474R
Bar for size 52 mm G	NT475R
Bar for size 54 mm H	NT476R
Bar for size 56 mm I	NT477R
Bar for size 58-62 mm J	NT478R
Bar for size 64-70 mm K	NT479R
Articulation attachment ø 28 mm	NT495
Articulation attachment ø 32 mm	NT496
Articulation attachment ø 36 mm	NT497
Articulation attachment ø 40 mm	NT498

Please order separately:	Art. no.
Plasmafit® X-ray templates scale 1.15:1	NT409



Plasmafit® MODULE SCREW FIXATION NT402

Consisting of:	Art. no.
Half module tray with supports 465 x 118 x 45 mm	NT403R
Flexible drilling shaft	NT419R
Drill bit ø 3.2 mm, length 32 mm	NT424R
Cardan screwdriver SW 3.5	NT428R
Depth gauge	NT427R

Please order separately:	Art. no.
Drill bit ø 3.2 mm, length 44 mm	NT429R
Drill guide straight ø 3.2 mm	NT421R
Drill guide curved ø 3.2 mm	NT423R
Screw holding forceps straight	NT432R
Screw holding forceps curved	NT433R
Drill bit ø 3.2 mm, length 20 mm	NT393R
Drill bit ø 4.0 mm, length 20 mm	NT394R
Drill guide straight ø 4.0 mm	NT422R
Drill guide curved ø 4.0 mm	NT425R
Drill bit ø 4.0 mm, length 32 mm	NT426R

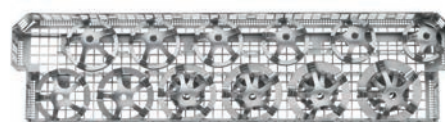

Plasmafit® MODULE TRIAL CUPS NT436

Consisting of:	Art. no.
Half module tray with supports 465 x 118 x 45 mm	NT437R
Trial cup ø 44 C	NT444R
Trial cup ø 46 D	NT446R
Trial cup ø 48 E	NT448R
Trial cup ø 50 F	NT450R
Trial cup ø 52 G	NT452R
Trial cup ø 54 H	NT454R
Trial cup ø 56 I	NT456R
Trial cup ø 58 J	NT458R
Trial cup ø 60 J	NT460R
Trial cup ø 62 J	NT462R
Trial cup ø 64 K	NT464R
Trial cup ø 66 K	NT466R
Trial cup ø 68 K	NT468R

Please order separately:	Art. no.
Trial cup ø 40 A	NT440R
Trial cup ø 42 B	NT442R
Trial cup ø 70 K	NT470R

AESCU LAP® Plasmafit®

8 | INSTRUMENTS



Plasmafit® MODULE TRIAL LINERS NT404

Consisting of:	Art. no.
Half module tray for maximum 16 trial liners 465 x 118 x 45 mm	NT405R
Forceps for trial liners	NT430R

Please order separately:

Liner size		A	B	C	D	E	F	G	H
symmetrical	ø 22.2 mm	NT482	NT483	NT484	-	-	-	-	-
	ø 28 mm	-	-	NT489	NT490	NT491	NT532	NT533	NT534
	ø 32 mm	-	-	-	-	NT501	NT502	NT503	NT504
	ø 36 mm	-	-	-	-	-	-	NT513	NT514
	ø 40 mm	-	-	-	-	-	-	-	-
posterior wall	ø 22.2 mm	NT582	NT583	NT584	-	-	-	-	-
	ø 28 mm	-	-	NT589	NT590	NT591	NT592	NT593	NT594
	ø 32 mm	-	-	-	-	NT601	NT602	NT603	NT604
	ø 36 mm	-	-	-	-	-	-	NT613	NT614
asymmetrical	ø 22.2 mm	NT682	NT683	NT684	-	-	-	-	-
	ø 28 mm	-	-	NT689	NT690	NT691	-	-	-
	ø 32 mm	-	-	-	-	NT701	NT702	NT703	NT704

I	J	K	L	M
-	-	-	-	-
NT535	-	-	-	-
NT505	NT506	NT507	NT508	NT509
NT515	NT516	NT517	NT518	NT519
NT525	NT526	NT527	NT528	NT529
-	-	-	-	-
NT595	-	-	-	-
NT605	NT606	NT607	NT608	NT609
NT615	NT616	NT617	NT618	NT619
-	-	-	-	-
-	-	-	-	-
NT705	NT706	NT707	NT708	NT709

NOTE

Plasmafit® Plus

Cup sizes 40-70 mm with liner sizes A-K

Plasmafit® Poly

Cup sizes 40-62 mm with liner sizes B-M

AESFULAP® Plasmafit®

8 | INSTRUMENTS

Additional Trays

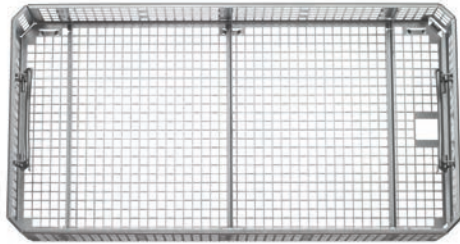

Two modules tray

Art. no.

Empty tray to store two modules
489 x 253 x 76 mm

NT399R

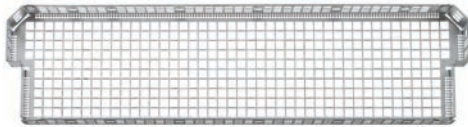

Half module tray

Art. no.

Half empty module tray
465 x 118 x 45 mm

NT398R



Small tray

Art. no.

Small empty tray to click into basic set
428 x 59 x 30 mm

NT397R

Lid to use with NT397R for separate storage

NT396R

Recommended containers for:

Plasmafit® basic set e.g. JK442
(592 x 274 x 135 mm)

Plasmafit® additional module tray e.g. JK441
(592 x 274 x 120 mm)

NOTES

A series of horizontal dotted lines for writing notes.

AESCULAP® – a B. Braun brand

Aesculap AG | Am Aesculap-Platz | 78532 Tuttlingen | Germany
Phone +49 7461 95-0 | Fax +49 7461 95-2600 | www.aesculap.com

Manufacturer acc. to MDD 93/42/EEC

BioloX:

CeramTec GmbH | CeramTec-Platz 1-9 | 73207 Plochingen | Germany

The main product trademark "Aesculap" and the product trademarks "ISODUR", "ISOTAN", "OrthoPilot", "Plasmafit", "Plasmapore" and "Vitelene" are registered trademarks of Aesculap AG.

"BioloX" is a registered trademark of CeramTec GmbH, Plochingen.

Subject to technical changes. All rights reserved. This brochure may only be used for the exclusive purpose of obtaining information about our products. Reproduction in any form partial or otherwise is not permitted.