



ORTHOPAEDIC
JOINT REPLACEMENT

AESFULAP[®] VEGA System[®]

KNEE ARTHROPLASTY

Operating Technique with IQ Instruments

AESCULAP® VEGA System®

1 | CONTENT



1	CONTENT	2
2	THE IQ INSTRUMENTS	4
3	INTRODUCTION	6
4	INDICATIONS PATIENT SELECTION	8
5	PREOPERATIVE PLANNING	9
6	APPROACH	10
	6.1 Medial parapatellar arthrotomy	11
	6.2 Mid-vastus arthrotomy	11
	6.3 Sub-vastus arthrotomy	11
	6.4 Final exposure	11
7	ASSEMBLY INSTRUCTIONS AND INSTRUMENT HANDLING	12
8	WORKFLOW SYNOPSIS	18

9	TIBIA PREPARATION	22	21	DIMENSIONS	63
	9.1 Extramedullary referencing	22	22	OVERVIEW OF PATELLA SIZES	64
	9.2 Intramedullary referencing	26	23	OVERVIEW OF EXTENSION STEM LENGTHS	64
	9.3 Tibia resection	28	24	LOANER SETS DEMO CASE	65
	9.4 Tibia keel preparation	29	25	IMPLANT MATRIX	66
	9.5 Tibia stem preparation	31	26	LITERATURE	68
10	FEMUR PREPARATION	33			
	10.1 Femur intramedullary alignment	33			
	10.2 Distal resection	34			
	10.3 Femur A/P sizing and rotation	35			
	10.4 Femur anterior, posterior and chamfer resections	37			
	10.5 PS box preparation	39			
11	GAP BALANCING	41			
	11.1 Tibia first – measurement with spacers	41			
	11.2 Optional tibia first – measurement with distractor	42			
	11.3 Femur first – measurement with spacers	43			
	11.4 Strategies	44			
12	PATELLA PREPARATION	45			
13	TRIAL REDUCTION	47			
14	PREPARATION AND ASSEMBLY OF EXTENSION STEMS	48			
15	COMPONENT IMPLANTATION	49			
16	CEMENTING TECHNIQUE	52			
17	CLOSURE	53			
18	INSTRUMENTS	54			
19	OPTIONAL INSTRUMENTS	60			
20	SAWBLADES	62			



AESCULAP® VEGA System®

2 | THE IQ INSTRUMENTS



THE IQ INSTRUMENTATION

The IQ VEGA System instrumentation has been designed to facilitate the workflow not only for the surgeon, but the operating room (OR) team as a whole, by enhancing ergonomics and operative efficiency. IQ stands for "Intuitive and Quick". The system offers multiple options covering different implantation philosophies that allow each surgeon to follow his/her preferred surgical technique.

- Precise and less instruments,
- Quick couplings,
- Ergonomic handles and
- Colour coding

are some aspects that will facilitate the surgical process in the operating room.

IQ – INTUITIVE & QUICK LESS IS MORE

The instruments as well as the instrument trays are colour coded to ease instrumentation and organization during the complete workflow:

- red = femur
- blue = tibia
- yellow = general
- grey = patella

The IQ VEGA System instruments are stored in the specially developed Aesculap OrthoTray. Both together, the IQ instruments plus Aesculap OrthoTray offer a high end reprocessing solution. The trays not only store the instruments in a secure and safe manner but also clearly facilitate the reprocessing procedure for the Central Sterilization Unit (CSU) as the instruments can remain in the tray during the washing process. This time saving solution generates an economic advantage and eliminates a potential source of error as complete set reassembling is needless.

THE Aesculap RESET

Aesculap RESET is an intelligent improvement of the Aesculap OrthoTray configuration. All size-specific instruments are packed such that only the sizes desired by the surgeon are used. Thus, the instrument and tray volumes in the entire instrument cycle are reduced by up to 50 %. Aesculap facilitates, as size-specific storage and washing system, the work of all the participants in the entire process. For further information please contact your responsible sales person.

NOTE

This wash tray system is only approved for the use with the cleaning validated instruments from Aesculap. Complex instruments, e.g. cutting guides or instruments that are introduced in the intramedullary (IM) canal during the procedure as drills and reamers require a manual pre-cleaning according to standard requirements.

AESCULAP® VEGA System®

3 | INTRODUCTION





VEGA System

Aesculap OrthoTray

The VEGA System is a posterior stabilized fixed platform knee endoprosthesis that has been developed to address modern arthroplasty requirements of surgeons and patients from all around the world.

An international group of experienced surgeons led by Drs. Saleh and Mihalko, have collaboratively combined their expertise and knowledge to design the next generation of knee implant systems – the VEGA System.

The VEGA System advanced technologies include the AS multi-layer coating and the unique kinematic design, which makes the system a first-choice for surgeons and patients alike.

The extensive range of femoral and tibial component size options allows for ideal gender, stature and morpho-type matching.

The VEGA System IQ instrumentation has been designed to facilitate the workflow not only for the surgeon, but the OR team as a whole, by enhancing ergonomics and operative efficiency. The system offers multiple options covering different implantation philosophies that allow each surgeon to follow their preferred surgical technique. Precise instruments, quick couplings, ergonomic handles, and color coding are some aspects that will facilitate the surgical process in the operating room.

AESCULAP® VEGA System®

4 | INDICATIONS | PATIENT SELECTION



The VEGA System PS is indicated for nearly all patients who are candidates for a primary TKA. Patients presenting with metal sensitivity can be preferred treated with the AS coated VEGA System implants.

For more information about indications and contraindications, please refer to the instructions for use TA012000.

5 | PREOPERATIVE PLANNING



For every Total Knee Arthroplasty, careful preoperative X-ray planning is recommended in order to determine precisely the following parameters:

- Varus/Valgus deformity
- Angle between the anatomical and mechanical femoral axes
- Entry point(s) of the intramedullary alignment rods (manual IM technique)
- Joint line level
- Femur resection heights
- Tibia resection heights
- Component sizing
- Implant positioning
- Potential areas of bone losses and location of osteophytes

The following X-ray images are required to conduct the radiographic analysis:

- Knee joint in A/P projection: knee extended, centered over the distal patella.
- Knee joint in lateral projection: knee in 30° flexion, centered above the distal patella.
- Image of the whole leg (from hip to ankle) in monopodal stance.
- Patella-tangential image (Merchant View) with the knee at 30° flexion.

The angle between the mechanical and anatomical femur axes is measured with the combination template for axis measurements. The center of the joint, the joint line and the mechanical femur axis can be measured. To determine the tibia resection, the template showing representations of the tibial components is superimposed over and aligned with the X-ray image. The resection height is given at a 10-20 mm graduation. A complete set of radiographic templates is provided for the preoperative determination of the appropriate implant sizes. The localization of the osteophytes facilitates their removal, improving the mobility of the joint.

The VEGA System knee system provides a complete set of radiographic templates in different magnitudes (1.1 and 1.15).

The results of the preoperative planning should be documented in the patient's file and should be available during the operative procedure for reference.

AESCULAP® VEGA System®

6 | APPROACH



The VEGA System IQ instrumentation is designed for use with or without the use of OrthoPilot Navigation, for both conventional and less invasive approaches to the knee.

The initial skin incision is a straight midline or slightly oblique parapatellar skin incision starting 2 to 4 cm proximal to the superior pole of the patella and extending distally to the medial aspect of the tibial tubercle. The surgeon should decide on a patient basis how long the incision is necessary for proper visualization of the knee anatomy. A parapatellar skin incision will be of benefit to patients when attempting to kneel after the operation.

The length range of the incision is generally between 8 and 14 cm symmetrically distributed above and below the joint line. Extension of the skin incision may be necessary during the procedure depending on the patient anatomy, the soft tissues and the skin tension.

Three basic types of arthrotomies are recommended for use to carry out the intra-articular exposure: the medial parapatellar, the mid-vastus or the sub-vastus.^{1,2}

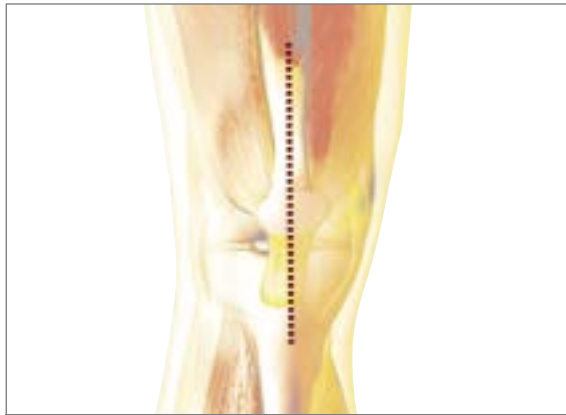

Skin incision



Medial parapatellar arthrotomy



Mid-vastus arthrotomy



Sub-vastus arthrotomy

6.1 Medial parapatellar arthrotomy

With the knee in flexion or extension, the arthrotomy is performed starting proximal to the superior pole of the patella, incising the rectus femoris tendon longitudinally. Continuing the arthrotomy distally around the medial aspect of the patella, and ending medial to the tibial tubercle is then carried out.

6.2 Mid-vastus arthrotomy

With the knee in flexion, the arthrotomy is performed starting by a split of the fibers from the vastus medialis oblique (VMO), continuing distally around the medial aspect of the patella, and ending medial to the tibial tubercle.

6.3 Sub-vastus arthrotomy

With the knee in flexion, the arthrotomy is performed starting with a 4 to 6 cm incision of the fascia at the inferior border of the VMO, running horizontal to the medial aspect of the patella, continuing and ending distally medial to the medial tubercle.

6.4 Final exposure

A fat pad excision is performed in order to facilitate the exposure and to improve the patella mobility. Perform the necessary medial release at this time that corresponds to the deformity. The patella can then be everted or sub-luxated laterally.

AESCU LAP® VEGA System®

7 | ASSEMBLY INSTRUCTIONS AND INSTRUMENT HANDLING



A	TIBIA EXTRA-MEDULLARY ALIGNMENT	13
B	TIBIA INTRA-MEDULLARY ALIGNMENT	14
C	FEMUR INTRA-MEDULLARY ALIGNMENT	14
D	A/P AND ROTATION ALIGNMENT BLOCK	15
E	TIBIAL/DISTAL CUTTING GUIDE	17

A | TIBIA EXTRA-MEDULLARY ALIGNMENT – ASSEMBLY INSTRUCTIONS

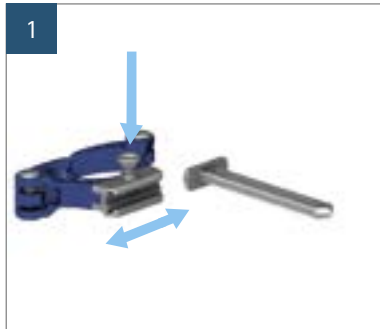

- Press the upper button on the bimalleolar clamp.
- Engage the support in the groove.
- When the neutral position is reached, release the button.



- Turn the wheel of the tibial alignment handle to the open position, "OP-EN" will be displayed.
- Engage the handle onto the bimalleolar support.
- Adjust to the neutral position.

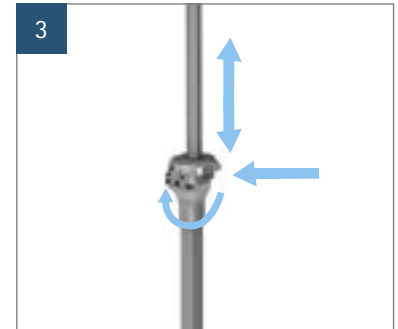

- Push on the handle adjusting wheel to release the locking mechanism.
- Engage the holding rod in the handle.
- Release the wheel when the desired level is reached.
- Turning the wheel will allow a fine adjustment of the height.

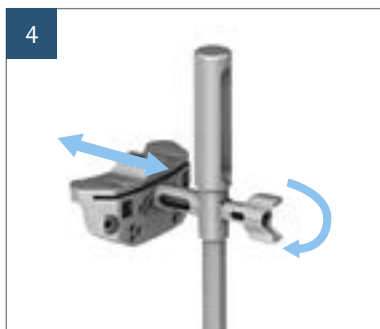

- Engage the holding rod in one of the connection squares of the tibial cutting guide.
- Lock the assembly by turning the frontal wheel.



- The proximal fixation is set through the proximal opening of the holding rod.
- Turn the tab into a horizontal position to fix the assembly.



- The connection square of the stylus is engaged in one of the connection squares of the tibial cutting guide.
- The connection is fixed by locking the wheel on the stylus.
- The resection height is adjusted to the desired bone cut level.
- The stylus can be placed over the proximal fixation.

AESCULAP® VEGA System®

B | TIBIA INTRA-MEDULLARY ALIGNMENT

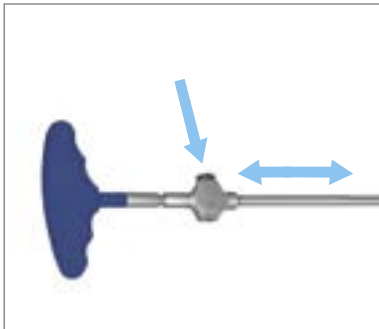

- Push on the button of the T-handle to release the locking mechanism.
- Couple the T-handle to the IM rod.
- Release the button to lock the assembly.

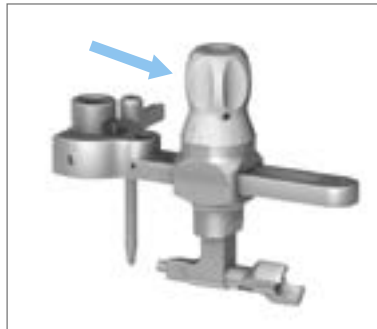

- Choose the IM orientation sleeve corresponding to the desired posterior slope resection of the tibia (default is 0° sleeve; sleeves with 3°, 5° and 7° posterior slope are available).
- Connect the sleeve to the IM alignment system.



- Mount the assembly into the alignment block.
- Connect the alignment system to the tibia cutting guide in one of its connection squares.
- Fix the connection by locking the wheel.

C | FEMUR INTRA-MEDULLARY ALIGNMENT

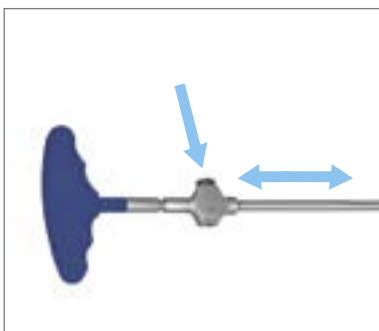

- Push on the button of the T-handle to release the locking mechanism.
- Couple the T-handle to the IM rod.
- Release the button to lock the assembly.

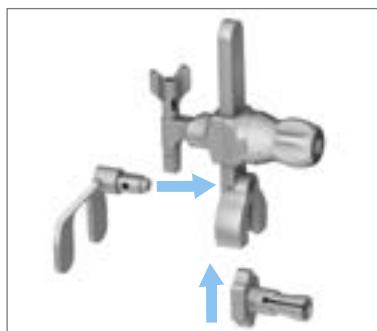

- Choose the IM orientation sleeve corresponding to the desired valgus alignment (standard: 5, 6, or 7°).
- Connect the sleeve to the IM alignment system.
- Connect a distal femur contact plate (small or large).



- Mount the assembly into the alignment system.
- Connect the alignment system to the tibia cutting guide in the central connection square.
- Fix the connection by locking the wheel.

D | A/P AND ROTATION ALIGNMENT BLOCK

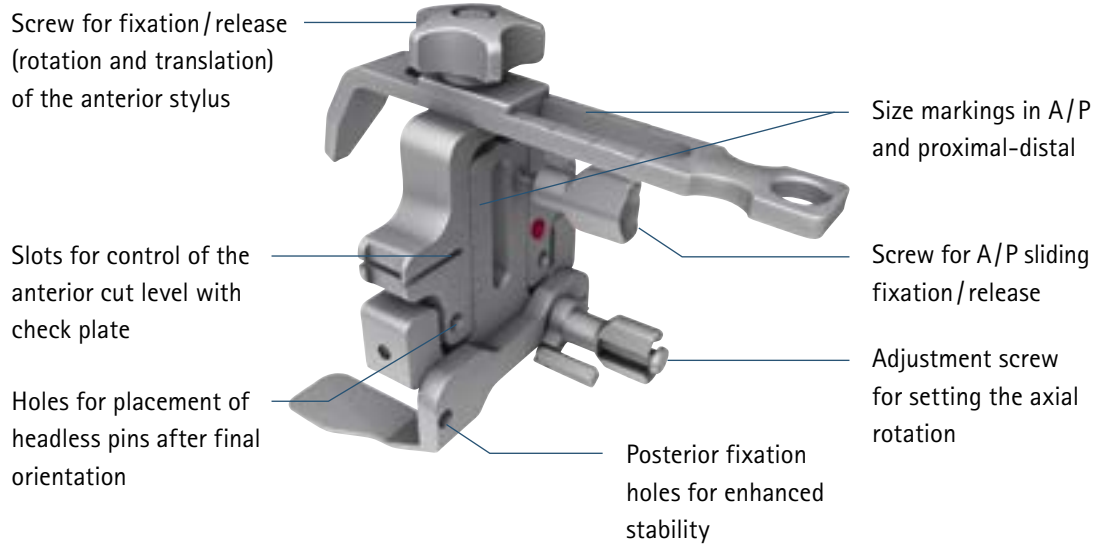

- **Option 1:** the rotation is pre-fixed to a desired value before the block is put in place.
- **Option 2:** the rotation is free and the block is placed in contact with the distal femur and the posterior condyles; the rotation can be tuned by turning the posterior wheel, checking the alignment of the A/P window with the femur A/P plane (Whiteside line).
- Due to the fixed distance between the pin placement holes and the anterior cortex stylus, the placed pins can be used for any femoral size chosen by the surgeon. Oversizing or downsizing the femur is achieved simply by choosing a different 4-in-1 cutting guide size and placing on the same previously placed pins.

AESFULAP® VEGA System®

D | A/P AND ROTATION ALIGNMENT BLOCK



- The anterior point to be palpated is located on the lateral anterior cortex, avoiding the risk of anterior notching.
- If the palpation is done at the middle of the anterior femur, the grand piano sign will be bigger providing a larger surface of contact.
- The stylus can be adjusted in the caudo-cranial direction in order to get a congruence between the A/P sizing and the proximo-distal sizing determined by the scale on the upper part of the stylus.

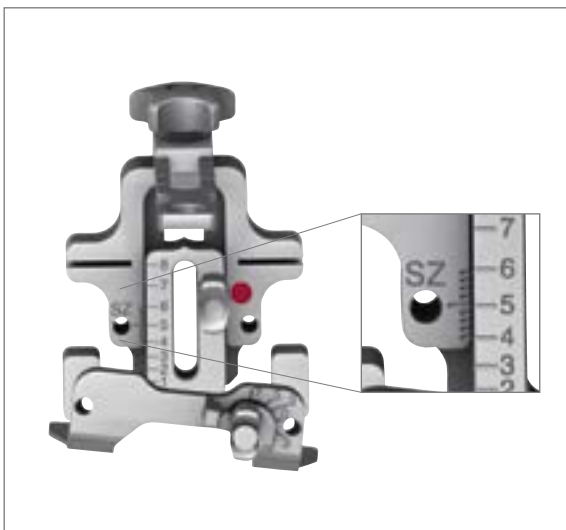

- After defining the right axial rotation of the block, if an exact femoral size is measured like in the example on the left, fix the A/P sliding by tightening the corresponding screw, place 2 headless pins in the placement holes.
- By loosening the screws, and, if used, removing the posterior enhanced fixation pins, remove the orientation block.

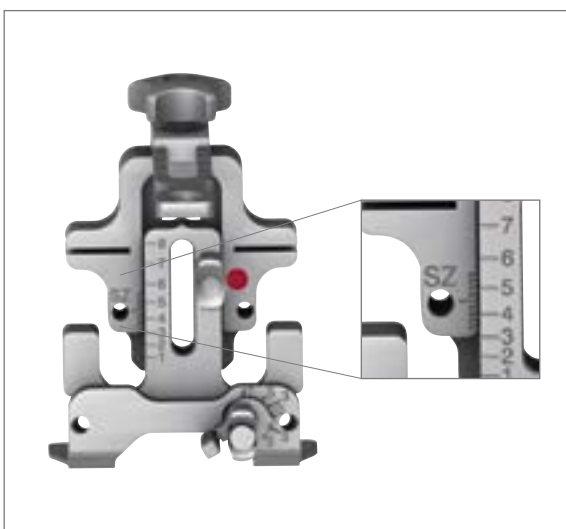

- After defining the right axial rotation of the block, if the measured size is in between two exact sizes like in the example on the left, fix the A/P sliding by tightening the corresponding screw, place 2 headless pins in the placement holes.
- By loosening the screws, and, if used, removing the posterior enhanced fixation pins, remove the orientation block.
- In this case, choose the direct upsize or downsize based on the assessment of the medio-lateral dimension and the flexion-extension gap situation. A smaller size will enlarge the flexion gaps; a bigger size will reduce the flexion gaps.

E | TIBIAL/DISTAL CUTTING GUIDE

Distal resection or tibial resection with a standard approach

- The connection to the alignment system to be used is the central one marked "C", denoted by the green square in the left picture.
- The fixation holes for the headless pins to be used correspond to the groups marked "C", shown by the red circles on the left picture.
- Enhanced fixation is achieved with one or two converging pins in the holes marked with the blue circles.



Right knee tibial resection with a less invasive approach

- The connection to the alignment system to be used is the one marked "R", shown by the green square in the left picture.
- The fixation holes for the headless pins to be used correspond to the groups marked "R", shown by the red circles in the left picture.
- Enhanced fixation is achieved with one converging pin in the hole marked with the blue circle.



Left knee tibial resection with a less invasive approach

- The connection to the alignment system to be used is the one marked "L", shown by the green square in the left picture.
- The fixation holes for the headless pins to be used correspond to the groups marked "L", shown by the red circles in the left picture.
- Enhanced fixation is achieved with one converging pin in the hole marked with the blue circle.



AESCULAP® VEGA System®

8 | WORKFLOW SYNOPSIS – FEMUR FIRST

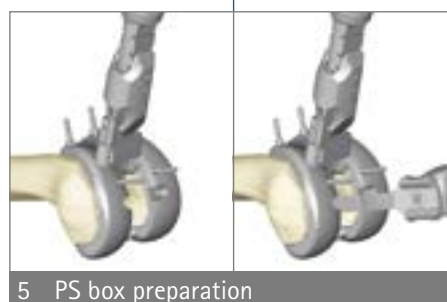
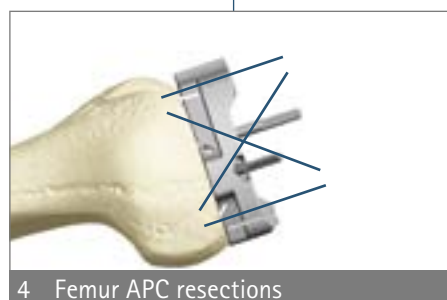
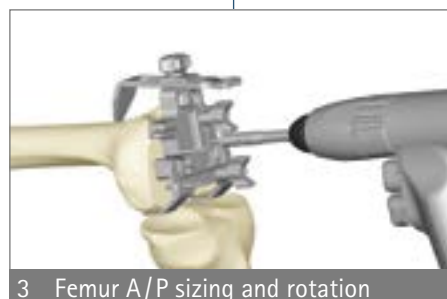



or

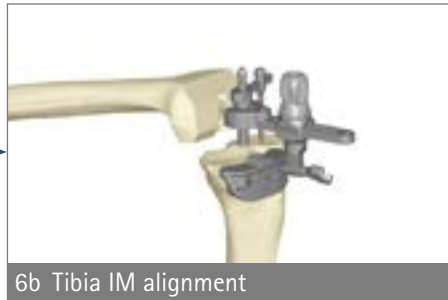

optional

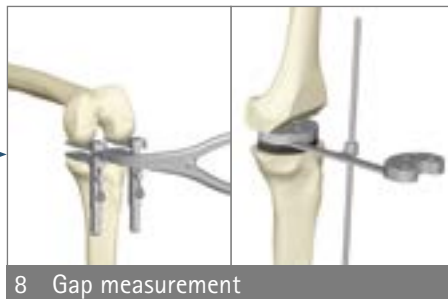

optional

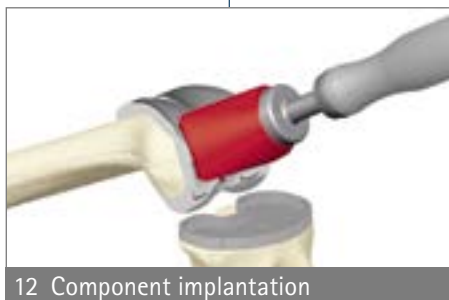
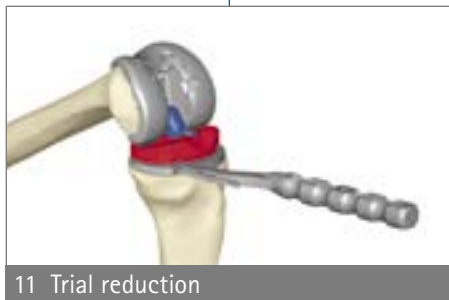

AESCULAP® VEGA System®

8 | WORKFLOW SYNOPSIS – TIBIA FIRST



or

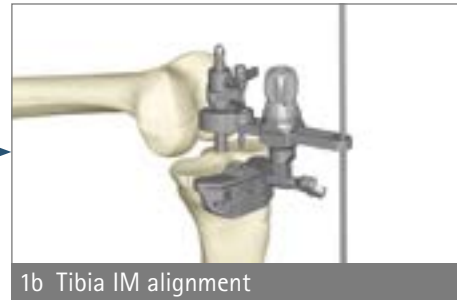

optional

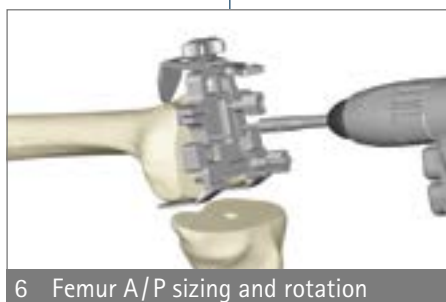
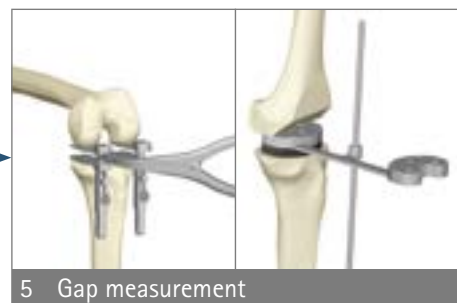

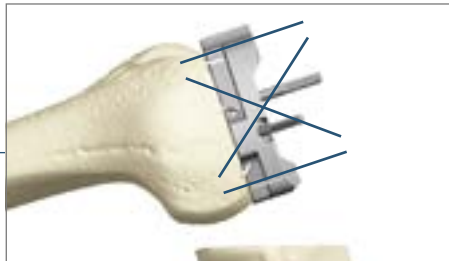

7 Femur APC resections



8 PS box preparation



9 Tibia keel and stem preparation

optional



10 Patella preparation



11 Trial reduction



12 Component implantation

AESCULAP® VEGA System®

9 | TIBIA PREPARATION



9.1 Extramedullary referencing

- The EM alignment system assembly is placed in a parallel fashion with the frontal tibia with the leg positioned in flexion.
- The bimalleolar clamp, previously set in a neutral position, is fixed around the lower limb just above the ankle joint and centered on the tibio-tarsian joint.
- Proximally, the EM alignment system can be stabilized with the proximal fixation first by engaging the longest spike between the tibia spines.
- When the rotation has been adjusted to the mid-third of the tibial tuberosity and the second toe axis (or according to the patient's individual anatomy since these landmarks may not be in line with the mechanical axis of the tibia), the second spike can be impacted defining the final tibia rotation.

INSTRUMENTS



Bimalleolar clamp NS345R



Bimalleolar clamp support NS344R



Alignment system handle NS342R



Holding rod for cutting guide NS341R



Tibia cutting guide NS334R



Proximal fixation NS343R

Varus/valgus alignment

Pushing the knob (1) at the bimalleolar clamp, and sliding the alignment system medially or laterally allows to adjust the varus/valgus of the proximal tibia resection. The distance between the laser marked lines on the scale corresponds to a 1° adjustment for a 40 cm long tibia.



Tibia slope alignment

Releasing the fixation wheel (2) at the bottom part of the alignment system (by aligning OP-EN), the alignment system can be shifted anteriorly in order to increase the slope of proximal tibia resection. The distance between the laser marked lines on the scale corresponds to a 1° adjustment for a 40 cm long tibia.

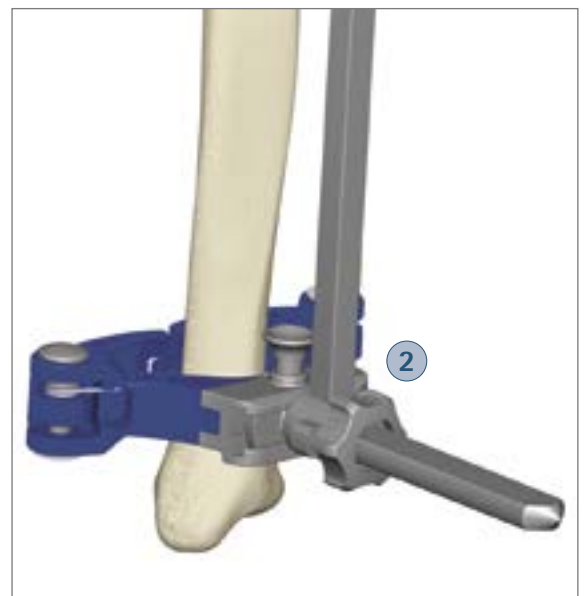

Tibia stylus NS347R

AESCULAP® VEGA System®

9 | TIBIA PREPARATION



Height adjustment (3)

- The resection height is determined in preoperative planning. The aim is to remove any defect on the tibial joint surface as completely as possible in order to create a bed for the tibia plateau on intact bone for optimal support of the implant.



- The planned value is set on the stylus, which is then mounted into the tibia cutting guide. The extramedullary alignment instrument is then lowered until the stylus comes into contact with the chosen point.
- Referencing the healthy tibia plateau is helpful to determine the level of the joint line. Referencing the deepest point of the worn side of the tibia helps to reduce the cut by resecting only 2 mm. Preoperative planning and surgeon preference are used to determine which reference to use.

INSTRUMENTS



Bimalleolar clamp NS345R



Bimalleolar clamp support NS344R



Alignment system handle NS342R



Holding rod for cutting guide NS341R



Tibia cutting guide NS334R



Proximal fixation NS343R

- The cutting guide is fixed with two headless pins in position "0". The +/-2 mm pinholes are available on the resection blocks to further adjust the resection level if needed. To avoid movements during the resection, additional pins are set in convergent holes as marked.

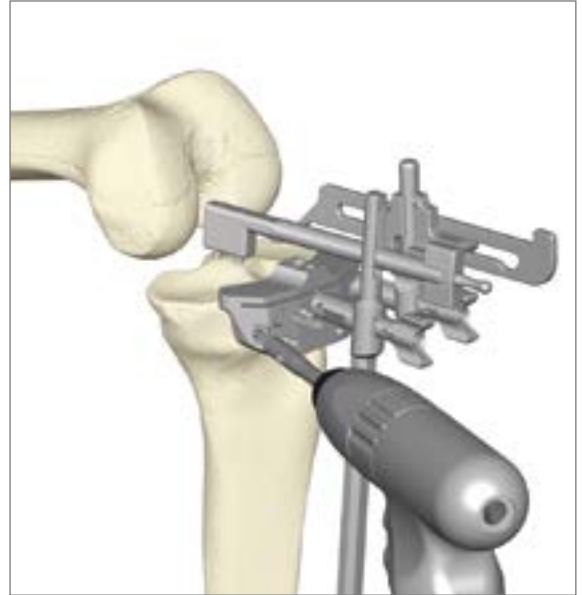

- The EM tibia alignment system is then disconnected from the tibia cutting guide by turning the connecting wheel counter-clockwise. The proximal fixation can be removed by disengaging the spike from the tibial spine.



Tibia stylus NS347R

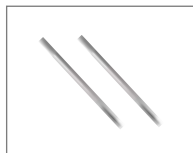

Headless pins 63 mm
NP583R



Pin driver NP613R



Acculan drill

AESCULAP® VEGA System®

9 | TIBIA PREPARATION



9.2 Intramedullary referencing

- The medullary canal of the tibia is opened with the Ø 9 mm starting drill bit. The surgeon has to pay close attention on the drilling direction in order to avoid cortical violation of the posterior metaphysis.



- The intramedullary rod is inserted into the prepared canal, after the contents are irrigated and suctioned, with the help of the T-handle. Once the T-handle is removed, the intramedullary alignment system is mounted on the rod with the chosen posterior slope angle sleeve (0, 3, 5, or 7°) and the cutting guide.

ATTENTION

Big tibia slope may create an anterior cortex conflict when (long) extension stems are used!

INSTRUMENTS



Drill Ø 9 mm NS330R



T-handle NE198R



IM alignment rod NS331R



IM alignment system NS332R



Tibia cutting guide NS334R



Tibia IM stylus for orientation sleeves NS847R

- The stylus is set on the deepest point of the tibia plateau to define the 0-level cut. The height of the cut is then adjusted by turning the tuning wheel to the desired amount of resection in millimeters.



NOTE

The surgeon should realize that the matched implant resection for the tibia is 10 mm.

- The alignment of the cutting guide can be checked with the alignment rod.

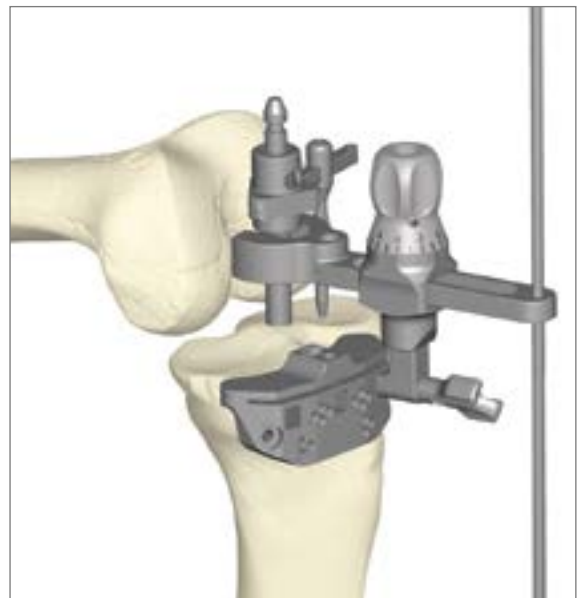

Alignment rod long
NP471R



Tibia orientation sleeve
0°, 3°, 5°, 7° NS843R-
NS846R

AESCULAP® VEGA System®

9 | TIBIA PREPARATION

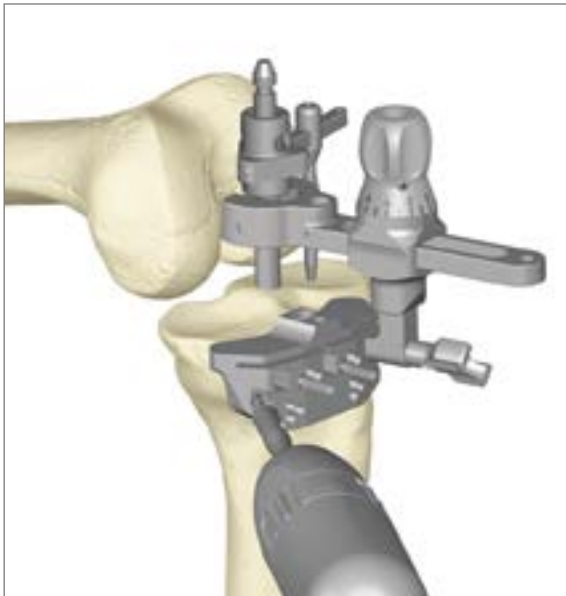

- The cutting guide is fixed with two headless pins in position "0". The +/- 2 mm pinholes are available on the resection blocks to further adjust the resection level if needed. In order to avoid movements during the resection, additional pins are set in convergent holes.
- The IM tibia alignment system is removed in one step with the T-handle after unlocking the cutting guide from the alignment system by turning the locking wheel in a counterclockwise direction.



9.3 Tibia resection

- Once the cutting guide is positioned and fixed, the proximal tibial resection is performed. (See note)
- After performing the proximal tibial resection the block is removed and the resected bone taken away. A careful inspection of the peripheral resection is mandatory in order to check that no remaining bone stock is present. Further removal of meniscal remnants and osteophytes that encroach the posterior capsule is then performed.

NOTE

The protection of the surrounding soft tissue sleeve of the knee joint is paramount. A special attention has to be paid: use of Hohmann retractors, collaterals retractors, PCL retractor is recommended in order to protect the ligaments during the resection.

INSTRUMENTS



IM alignment rod NS331R



IM alignment system NS332R



Tibia IM stylus for orientation sleeves NS847R



Tibia cutting guide NS334R

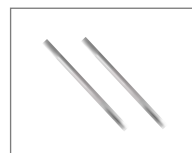

Headless pins 63 mm NP583R



Tibia orientation sleeve 0°, 3°, 5°, 7° NS843R-NS846R

9.4 Tibia keel preparation

- The size of the tibia is determined by superposing the different tibia preparation plateau sizes onto the created surface trying to reach the best bony coverage with the proper transverse rotational alignment of the trial baseplate while avoiding M/L and A/P overhang. As the design of the VEGA System tibia plateau is symmetric a perfect tibial coverage and a correct tibial rotation cannot be reached at the same time. Wrong rotational alignment should be avoided.
- The chosen tibia trial preparation is placed flush onto the tibia resection and the rotation is assessed with the help of the EM rod placed through the holder. References for the rotation are the mid-third of the anterior tuberosity and the second toe axis of the leg. These two landmarks are often not coincident with mechanical axis of the tibia and the surgeon should consider the rotation with respect to the tubercle to maintain extensor mechanism alignment. The plateau is fixed by the short headed pins in the marked holes.
- Another option consists in building the tibia and femur trial implant with the adequate trial gliding surface. By exercising flexion extension movements combined with slight rotational stresses, the tibia plateau will find a natural position under the femur trial. This position is marked anteriorly using the electric cautery right where the plateau has a central anterior laser marking. Care should be taken to assess the stability of the extensor mechanism before accepting this "free float" alignment of the tibial baseplate.

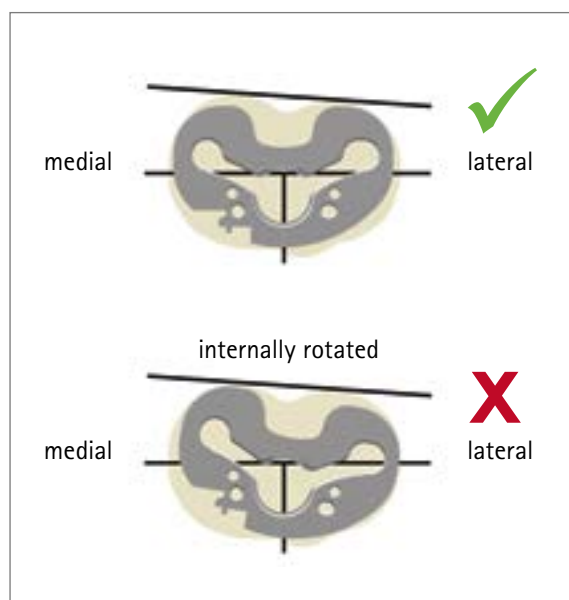
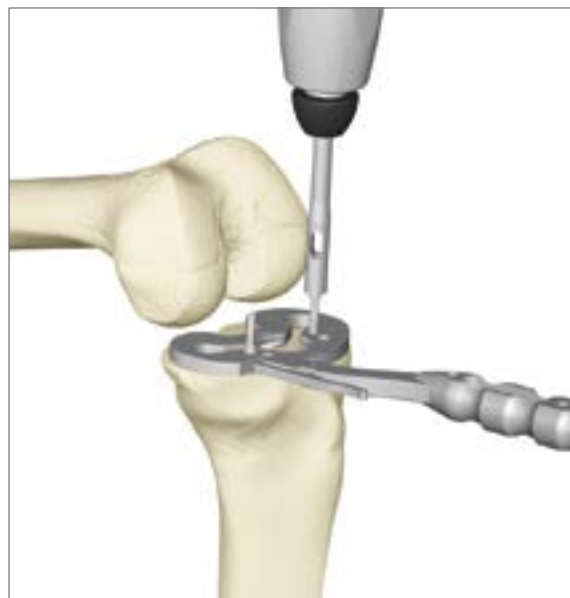

Acculan drill



Acculan saw



Tibia trial/preparation plateau NS349R-NS359R

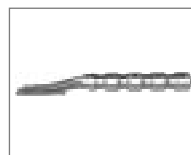

Tibia trial/preparation plateau holder NQ378R



Headed pins 30 mm NP585R



Pin driver NP613R

AESCULAP® VEGA System®

9 | TIBIA PREPARATION



- The holder is removed. The guiding tower is placed on the tibia plateau by engaging the posterior teeth first. The anterior part can be maintained steady by replacing and locking the holder back in place.
- The 12 mm drill with stop is first used to prepare the bone for the winglet chisel.
- If the PEEK plug is used the stem has to be prepared until the marking on the drill is reached. The drill length until the stop presents the length of the tibial site with the 12 mm short stem. In case of the use of the obturator screw the stem preparation will be prepared until the stop like with the 12 mm stem.



- The wing stem preparation is performed by using the winglet chisel connected to its handle through the guiding tower down to the stop. There is a small winglet rasp for tibia size T0-T2+ and a big winglet rasp for tibia size T3-T5 available as the tibia wing stem of the final implant is growing for the bigger tibia sizes. The winglet rasp can stay in place for the trial reduction or can be removed by using the slap hammer.

INSTRUMENTS



Tibia trial/preparation plateau NS1081R-NS1085R



Headed pins 30 mm NP585R



Guide for winglet chisel NS1033R



Drill with stop Ø 12 mm NS1029R



Acculan drill

9.5 Tibia stem preparation

- In case of poor bone quality, the primary fixation can be enhanced by using a stem extension. According to the surgeon's philosophy, a cemented stem or a cementless stem can be chosen.

Option 1: priority to the tibia resection

In this case, the tibia preparation is performed following the steps described previously (chapter 9.1 to 9.4). At the last stage, instead of using the standard Ø 12 mm drill, a long drill is used for preparing the site of the future stem.

Length and diameter of this long drill should be assessed on the pre-operative X-rays. The drilling is performed through inserts for the guiding tower and the diameter (Ø 12, 14 or 16 mm) corresponds to the trial stem diameter. For cemented stems, the drills are 2 mm wider than the final tibial stem to prepare a 1 mm surrounding cement mantle (1 mm on each side = 2 mm). For the preparation of cementless stems, the drill diameter fits to the diameter of the stems. Two laser markings are available on the drill in order to define the right depth for short or long stems. For the winglet preparation, the corresponding trial tibia stem is connected to the winglet chisel for the final preparation.

Please note that this option is indicated for cemented stems.

NOTE

VEGA System implants have a symmetric tibia plateau. Therefore it is essential to reach a good transverse rotational alignment. A perfect bony coverage is not aspired (see picture beside).

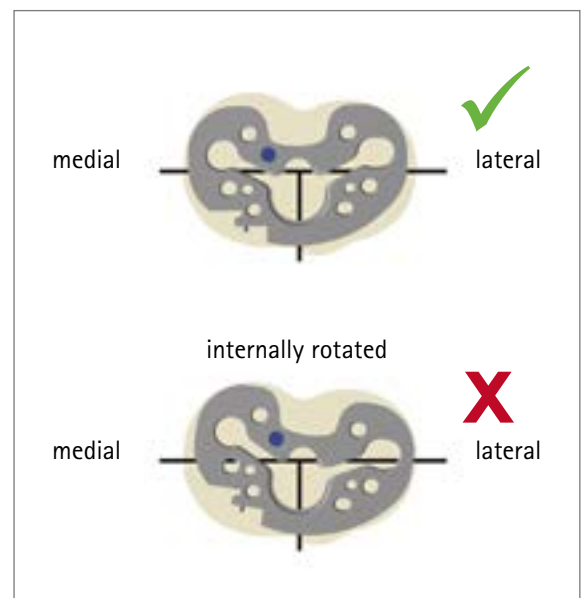

Winglet chisel/Trial keel
NS1031R, NS1032R



Osteodensometer holder
NQ378R



Tibia drill sleeve for
cemented stem
NS1034R-NS1036R



Drill for cemented
stem NS376R-NS377R,
NS380R



Trial stem cemented
NS384T-NS386T,
NS387T-NS389T

AESCULAP® VEGA System®

9 | TIBIA PREPARATION

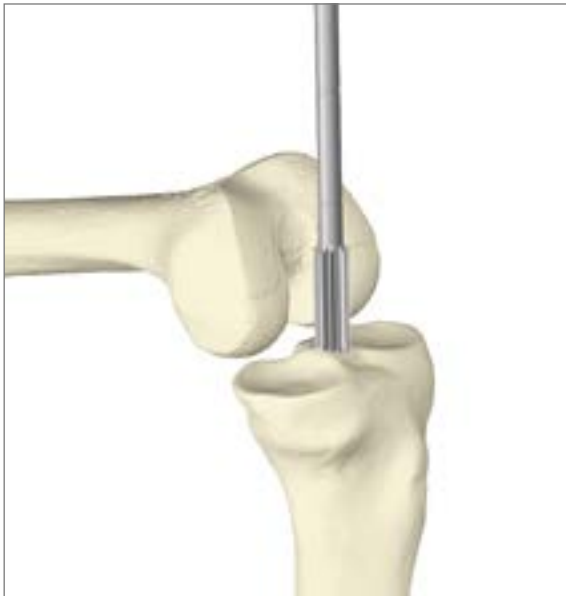

Option 2: priority to the extension stem fixation

In this case, the medullary canal of the tibia is opened according to the preoperative planning (entry point) with the Ø 9 mm drill. The thinnest reamer is then coupled to the T-handle and inserted into the tibia medullary canal as deep as possible until a primary stability is achieved and a depth laser marking reaches the estimated level of the tibia resection (short or long stem). If primary stability is not sufficient, a thicker diameter is used until stability is achieved. Once the T-handle is removed, the intramedullary alignment system is mounted on the reamer with the 0° angle sleeve (angled sleeve for slope is not possible here!) and the cutting guide. The stylus is set on the deepest point of the tibia plateau to define the 0-level cut.

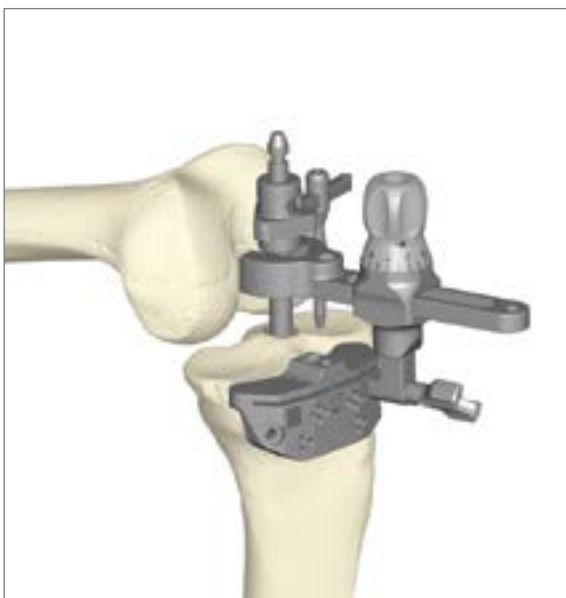

The height of the cut is then adjusted by turning the tuning wheel. The alignment of the cutting guide can be checked with the EM alignment rod. The cutting guide is fixed with two headless pins in position "0"; the +/-2 mm pinholes are available on the resection blocks to further adjust the resection level if needed. In order to avoid movements during the resection, additional pins are set in convergent holes if necessary. The IM tibia alignment system is removed in one step with the T-handle after unlocking the cutting guide from the alignment system. Please note that this option is indicated for cementless stems and the surgeon must take into account the alignment of the tibia as directed by the cementless stem since it may not coincide with the mechanical axis of the tibia.

INSTRUMENTS



Reamer for cementless stem NS391R-NS393R



IM alignment rod NS331R



IM alignment system NS332R



Tibia IM stylus for orientation sleeves NS847R



Tibia orientation sleeve 0°, 3°, 5°, 7° NS843R-NS846R



Tibia cutting guide NS334R

10.1 Femur intramedullary alignment

- The medullary canal of the femur is opened according to the preoperative planning (entry point) with the drill Ø 9 mm. The rod is inserted into the intramedullary canal using the T-handle. Once the rod is inserted, the T-handle can be removed.
- In order to compensate the anatomical valgus angulation of the femoral bone relative to the mechanical axis, the appropriate angle sleeve 5°, 6° or 7° according to the preoperative planning is set into the intramedullary alignment system. The distal femur contact plate and the cutting guide are connected to this system. The assembly is placed on the IM rod in contact with at least one distal condyle.



- The planned height of the distal resection is adjusted by turning the wheel (1) until the desired thickness matches the anterior laser marking. The standard resection is 9 mm and corresponds to the distal thickness of the implant. Contact plate has to be assembled to be in full contact with NS332R.

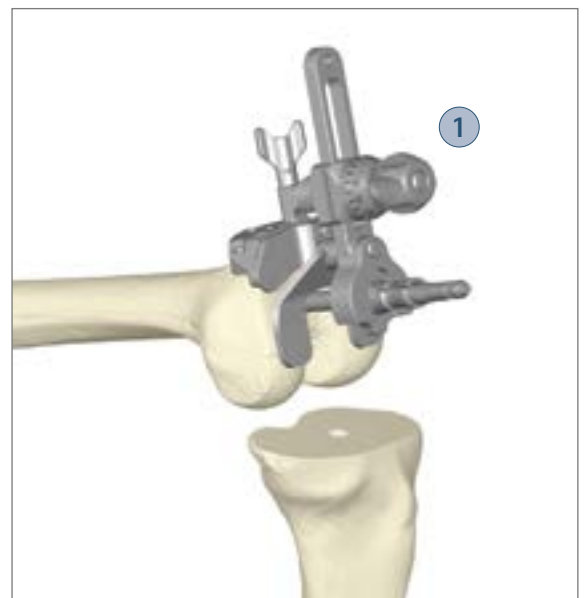

Drill Ø 9 mm NS330R



Acculan drill



T-handle NE198R



IM alignment system NS332R



Distal femur contact plate NS333R, NS834R



Femur orienting sleeve NS335R-NS337R



Cutting guide NS334R

AESCULAP® VEGA System®

10 | FEMUR PREPARATION

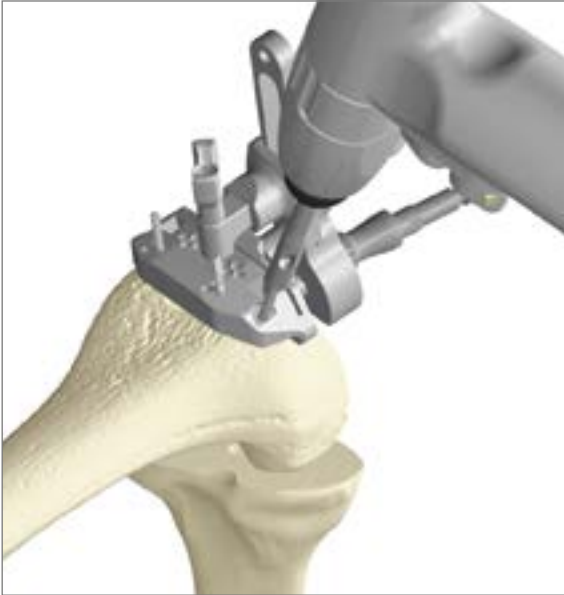

10.2 Distal resection

- The cutting guide is fixed with two headless pins in position "0". To avoid movement during resection, additional pins are set in convergent holes.

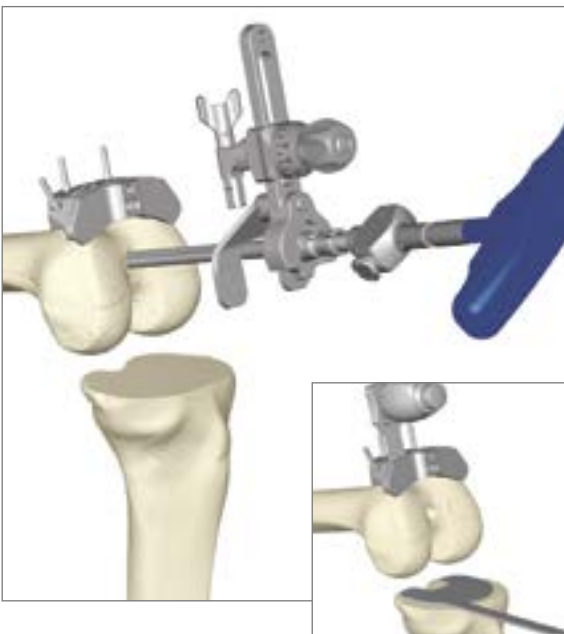

- The intramedullary alignment system is completely removed in one step with the T-handle by unlocking the connection to the cutting guide.
- The distal femoral resection is performed by sawing through the slot with a 1.27 mm thick oscillating sawblade. Make sure that the resection is fully completed and that no remaining bone structures are prominent to the resection plane.
- Pins and cutting guide are removed.

NOTE

Please always pay a great care to the lateral structures by protecting them if necessary by the use of Hohmann retractors.

INSTRUMENTS



IM alignment rod
NS331R



Tibia alignment
system NS332R



Distal femur contact
plate NS333R,
NS834R



Femur orienting
sleeve NS335R-
NS337R



Cutting guide
NS334R

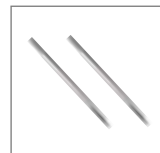

Headless pins 63 mm
NP583R



Acculan drill

10.3 Femur A/P sizing and rotation

NOTE

The VEGA System is a PS-Design and the resection of the PCL is obligate. After resection of the PCL the flexion gap might open up and could influence the choice of femoral implant size.

- The ML size of the resected femur should be checked with the ML femoral sizing gauge. One side specifies standard sizes, the other side narrow sizes.
- The femur alignment block is placed flush onto the resected distal surface of the femur. The posterior foot plate must be in contact with the posterior condyles. The femoral alignment block is fixed with two headless pins against the distal femur through the posterior holes.

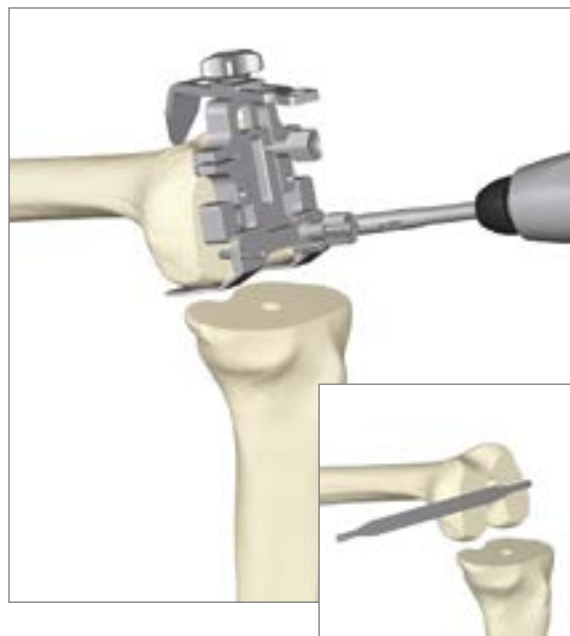

- The femur sizing is achieved by reading frontally the marked size on the scale when the stylus tip is placed at the intended exit point of the sawblade on the anterior lateral cortex in order to avoid any notching. A scale on the surface of the stylus indicates the femur size depth and the position can then be fixed by tightening the screw.



Femur alignment block NS340R



T-handle NE198R



Tibia protection plate NQ377R



Acculan saw



ML femoral size gauge NS339R



Pin driver NP613R

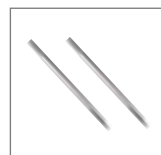

Headless pins 63 mm NP583R

AESCULAP® VEGA System®

10 | FEMUR PREPARATION



- It is possible to adjust the external rotation by moving the posterior lever arm in the correct direction (L=left, R=right). The rotational position is confirmed by assessing the trans-epicondylar axis perpendicularity or by checking the Whiteside's line through the slot at the middle of the instrument. Size and rotation are fixed by tightening the screw at the bottom lever arm.

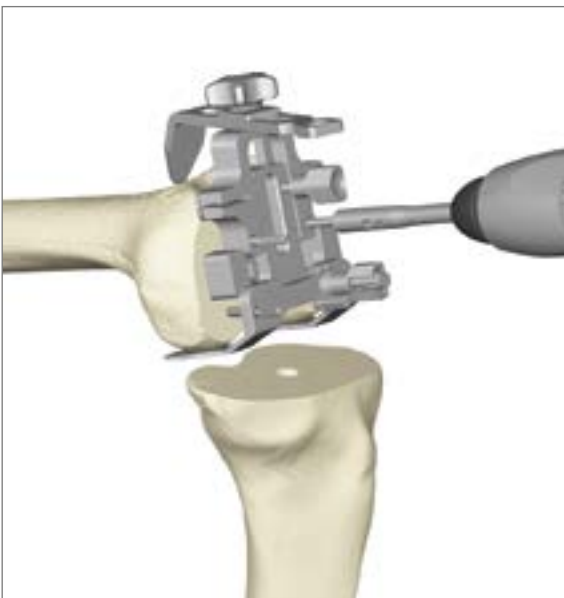

- Two long headless pins are fixed through the 2 frontal holes in order to reference the position of the 4-in-1 cutting guide. It is recommended to check the level of the anterior resection by using the check plate in the alignment block slots. The size to choose is to be read on the scale (see chapter 7 Assembly Instructions and Instrument Handling).
- The posterior pins and the block are removed, leaving the headless pins in place.

INSTRUMENTS



Femur alignment block
NS340R

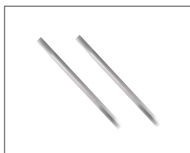

Headless pins 63 mm
NP583R



Pin driver NP613R



Acculan drill

10.4 Femur anterior, posterior and chamfer resections

- The 4-in-1 cutting guide that matches the femur size is placed over the two headless pins into the marked "0" mm pinhole and pressed onto the distal resection. It is advised to check the level of the anterior resection by using the check plate in the alignment block slots before placing the converging headed pins for fixation.
- Before fixing the guide with convergent pins, it is possible to adjust the A/P position by using the holes marked +/-2 mm in order to remain as close as possible to the anterior cortex without notching it.

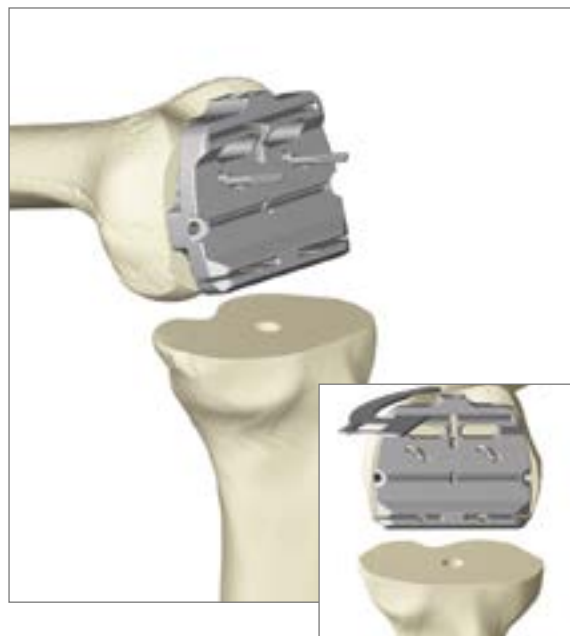

- The resections are performed as follow: anterior cut, posterior cut, removal of sizing pins, posterior chamfer, anterior chamfer. Thereby, the maximum distal contact surface and cutting guide fixation is preserved up to the last resection, ensuring stability.
- Convergent pins and cutting guide are removed, and the resections are carefully checked in order to detect any remaining bone stock.

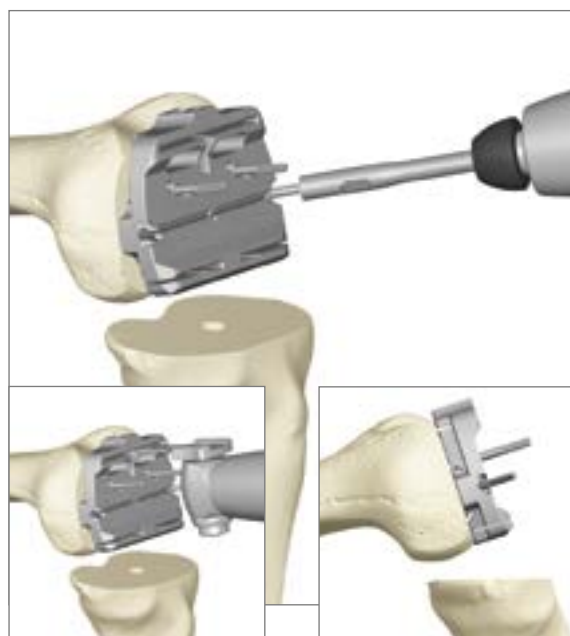

4-in-1 femur cutting guide NS321R-NS328R



Cutting depth check blade NS850R



Acculan saw

AESCULAP® VEGA System®

10 | FEMUR PREPARATION



- The quality of the resections and the fit of the prosthesis can be assessed by placing the femur trial implant onto the bone preparation. Using the corresponding holder with the fitting insert (small for size F1-F5, large for size F6-F8), make sure to apply a force toward anterior in order to avoid a flexed position.

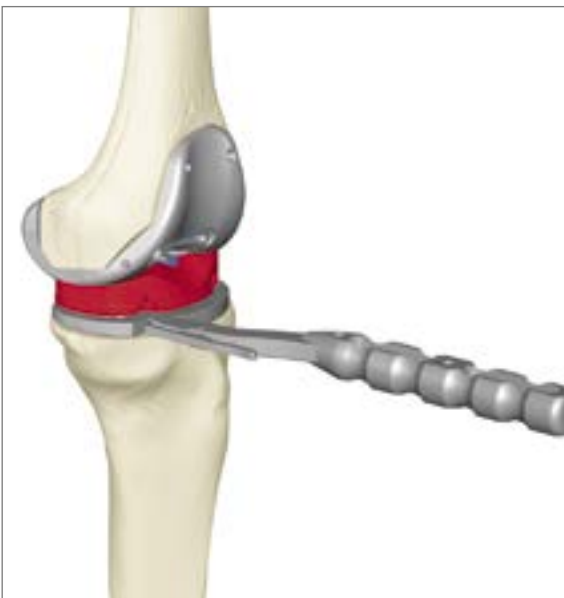

- A trial reduction can be done by to check the ligament situation and define the tibial rotation by insertion of the tibia trial preparation plateau and the gliding surface.

INSTRUMENTS



Trial femur insertion instrument NS600R



Insert for NS600R, NQ1031R-NQ1032R



Trial femur NS301RM-NS308RM, NS311RM-NS318RM



Tibia trial/preparation plateau NS349R-NS359R



Tibia trial/preparation plateau holder NQ378R



Trial gliding surface NS270-272, NS275-277, NS280-282, NS285-287, NS290-292, NS295-297

10.5 PS box preparation

- The trial femur implant is placed onto the prepared femur using the corresponding holder making sure to apply an extension force anteriorly in order to avoid a flexed position. The trial femur implant is fixed along the proximal trochlear groove with two headed pins.
- An added fixation can be achieved by using two long headless pins in the frontal holes in the distal section of the femur trial.

NOTE

The position of the distal holes pins corresponds exactly to the one of the orientation block (see chapter 10.3) and APC cutting guide (see chapter 10.4). So a quick repositioning for downsizing purpose is possible.

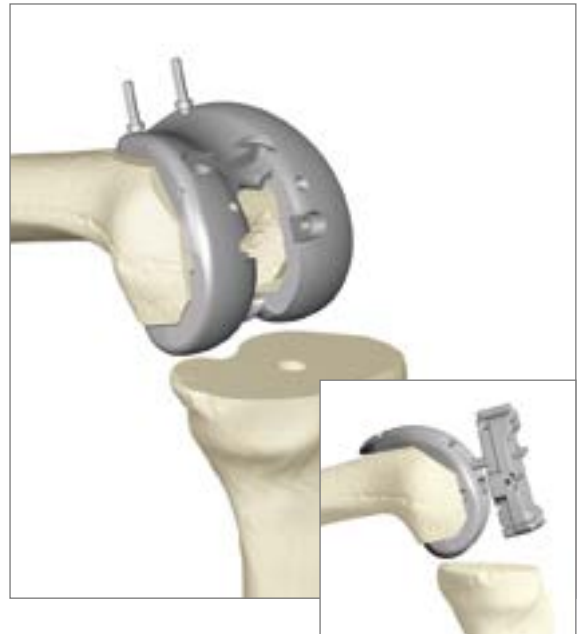

- The box chisel guide for the box roof resection is placed and screwed with the screw driver SW 4.5 onto the femur trial.
- The preparation of the box roof can be performed using the box chisel through the slot. It can also be achieved with the help of a reciprocating saw (GC769R or GC771R for Acculan 3Ti) or an oscillating saw with a 9 mm width blade (GE231SU for Acculan 3Ti).

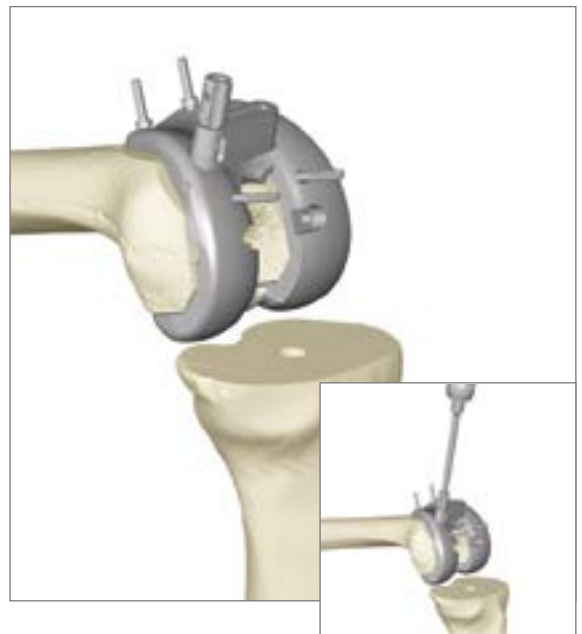

Spacer 6 mm NS274, NS279, NS284, NS289, NS294, NS299

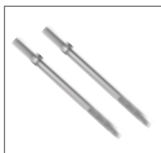

Headed pins 50 mm NP586R



Pin driver NP613R



Acculan drill

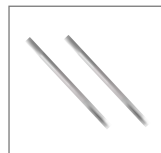

Headless pins 63 mm NP583R



Femur box chisel guide NS367R



Screw driver SW 4.5 NQ660R

AESCULAP® VEGA System®

10 | FEMUR PREPARATION

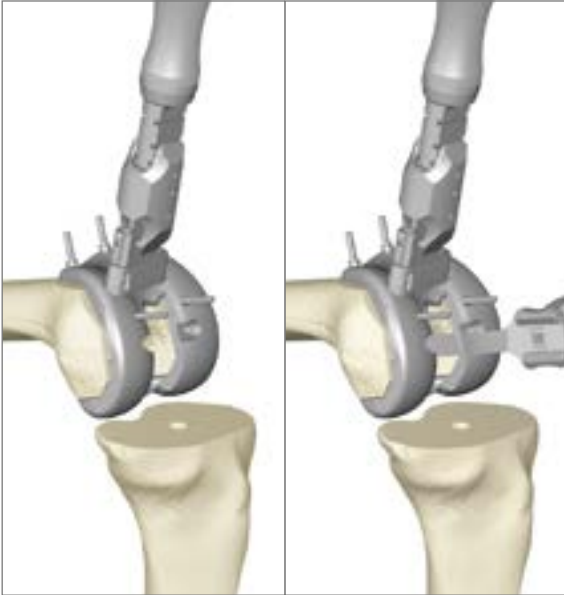

- When using the box chisel, the chisel stop has to be placed in the slot of the chisel that corresponds to the size of the femur. This will avoid violation of the posterior capsule by stopping the chisel at the respective depth. The display of femur sizes should be readable in distal direction to ensure that the cutting edge of the box chisel is positioned correctly.
- The medial and lateral inner box wall cuts are performed with a sawblade with the chisel left in place, so that it will stop the sawblade at the appropriate depth.
- After the box preparation, the trial box can be engaged onto the trial femur at the corresponding side guiding ears. If the ears are prominent and not flush with the trial femur articular geometry, then the box cuts need to be reworked by assessing the box preparation area for residual bone until the ears are flush with the trial femur.

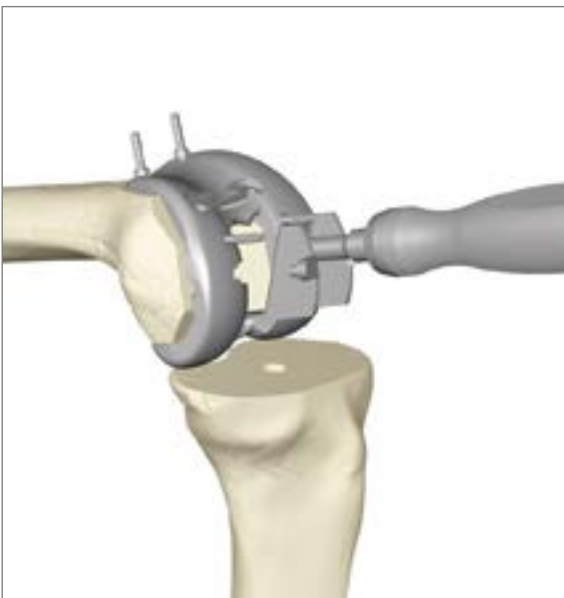

- Pins are removed, when the trial femur implant is removed or when the knee is repositioned for range of motion and stability.

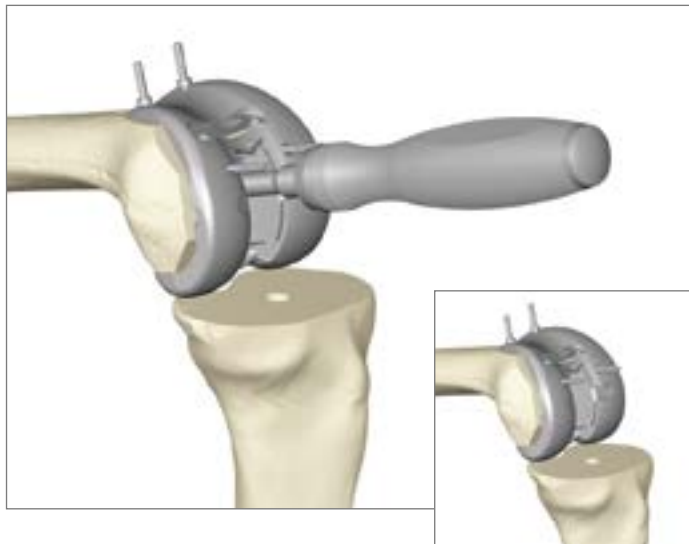

INSTRUMENTS



Trial femur
NS301RM-NS308RM,
NS311RM-NS318RM

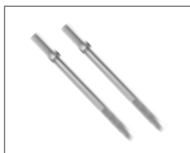

Headed pins 50 mm
NP586R

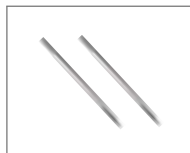

Headless pins 63 mm
NP583R



Femur box chisel guide
NS367R



Femur box chisel NS368R



Femur box chisel stop
NS369R

11 | GAP BALANCING

11.1 Tibia first – measurement with spacers

- After performing the tibia resection, check the plane of the resection by inserting the thinnest spacer block (10 mm) in the joint. If the resection needs correction then apply the cutting guide accordingly and recut the proximal tibia. The soft tissue gaps can be assessed by applying a varus/valgus stress in extension and in flexion. If the joint is too lax, insert the next thicker spacer and repeat the operation until a spacer thickness allows the knee to reach a stable point in flexion and extension. (Note: The PCL must be released and removed prior to assessing gaps in flexion and extension since it will increase the flexion gaps once removed.)
- If the medial and lateral gaps are asymmetrical, it is necessary to perform the appropriate soft tissue release on the contracted side and then repeat the gaps measurements with the spacers until stability is reached.



- If the flexion and extension gaps are incongruent then please refer to the chapter 11.4 Strategies and define the right corrective action.
- The thickness of the last spacer that allows good balance and stability of the knee corresponds to the needed polyethylene thickness that should be used.
- At each step, the leg axis can be checked by inserting the alignment rod through the spacer handle; the rod should point respectively at the femoral head center and the ankle joint center.
- The measurements can also be done after the distal resection is performed by adding the distal cut spacer for the extension measurement.



Acculan saw



Trial femur box NS821R-NS828R



Femur box holder/extractor NS428R



Tibia cut spacer NS852R-NS854R



Alignment rod long NP471R



Added femur cut spacer NS329

AESCULAP® VEGA System®

11 | GAP BALANCING

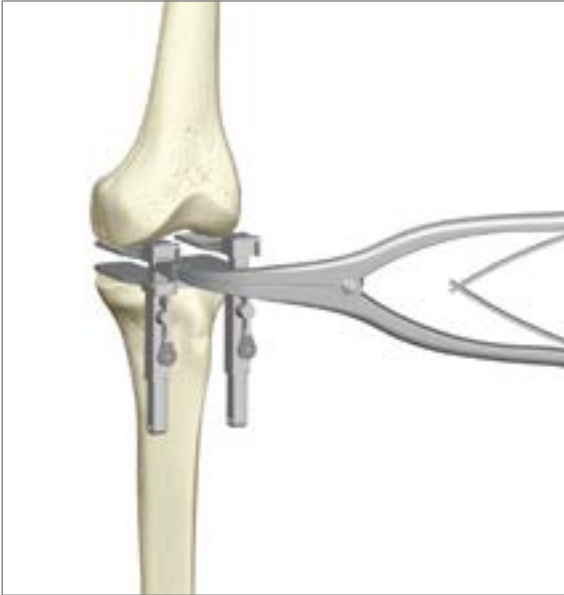

11.2 Optional tibia first – measurement with distractor

- After performing the tibia resection, check the plane of the resection so that it corresponds to the mechanical axis of the tibia. Insert the distractor into the joint and use the clamp to distract sequentially the medial and lateral gaps in extension.
- If the medial and lateral gaps are asymmetrical, it is necessary to perform an appropriate release on the contracted side and then repeat the gaps measurements.

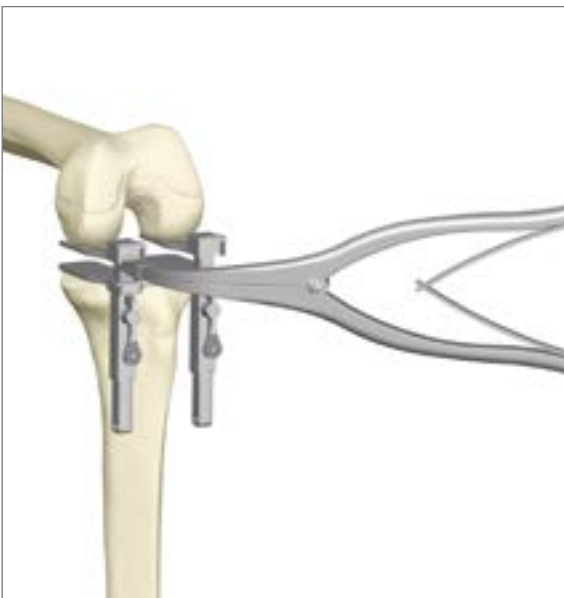

- When the joint is balanced in extension, note the thickness of the gaps, and move to the flexion gap measurement and repeat the same operation. In flexion, the possible future rotation of the femoral component should be taken into account.
- When the flexion gaps (FG) differ from the extension gaps (EG), calculate the needed thickness of the distal resection in order to equalize flexion and extension: $\text{distal resection height} = 9 \text{ mm} - \text{EG} + \text{FG}$. (Note: The PCL must be released and removed prior to this step since its removal will increase the flexion gaps.)

INSTRUMENTS



Distraction clamp
NP609R



Femur-tibia distractor
NP604R

11.3 Femur first – measurement with spacers

- After completion of the femoral and tibial resections, the trial femur implant is placed on the femur. The height of the resection and extension/flexion gaps can be checked by inserting the spacers.



Tibia cut spacer
NS852R-NS854R



Added femur cut spacer
NS329



Alignment rod long
NP471R

AESCU LAP® VEGA System®

11 | GAP BALANCING

		Flexion Gap		
		optimal	tight	wide
Extension Gap	optimal		<ul style="list-style-type: none"> ▪ increase tibia slope ▪ downsize the femur 	<ul style="list-style-type: none"> ▪ posterior capsule release and thicker insert ▪ increase distal cut and thicker insert ▪ increase femur size
	tight	<ul style="list-style-type: none"> ▪ posterior capsule release ▪ increase distal cut 	<ul style="list-style-type: none"> ▪ thinner insert ▪ increase tibia cut 	<ul style="list-style-type: none"> ▪ increase distal cut, release posterior capsule and thicker insert ▪ upsize femur and increase distal cut ▪ upsize femur and release posterior capsule
	wide	<ul style="list-style-type: none"> ▪ decrease distal cut ▪ downsize femur and thicker insert 	<ul style="list-style-type: none"> ▪ downsize femur and thicker insert ▪ downsize femur and decrease distal cut ▪ decrease distal cut 	<ul style="list-style-type: none"> ▪ thicker insert

11.4 Strategies

When the flexion and extension gaps are incongruent, an individualized strategy has to be defined in order to correct it.

The table presents some possible options to follow in order to correct a situation where the flexion and extension gaps are not both equally optimal but either tight or wide.

This does not pretend to be an exhaustive and systematic solution matrix. The surgeon has to make his own choices depending on the clinical evaluation, the surgical situation, patient specific issues and his own experience.

12 | PATELLA PREPARATION

- The thickness of the patella is measured using the caliper. This thickness should not be exceeded after implantation of the patella implant. The level of bone resection is calculated. A minimum thickness of remaining patella bone should not be less than 12 mm.
- The patella is clamped and the level of the resection is adjusted by turning the resection depth wheel to the planned level of remaining patellar bone thickness.
- The resection is performed through the cutting slot with a 1.27 mm thick sawblade.



INSTRUMENTS



Caliper AA847R



Patella resection clamp
NS840R



Acculan saw

AESCULAP® VEGA System®

12 | PATELLA PREPARATION



- The patella resection clamp is removed. The patella drill/impaction clamp is set onto the osteotomized patellar surface choosing a medialized position to recreate the resected apex of the articular surface; the trial patella can be placed on top of the drill guide in order to check its position to the medial rim and appropriate positioning in the superior and inferior direction.
- The peg holes of the implant are drilled through the drill-guide holes with the Ø 6 mm drill until the stop is reached. The size of the patella is established with the corresponding trial patellar implant.

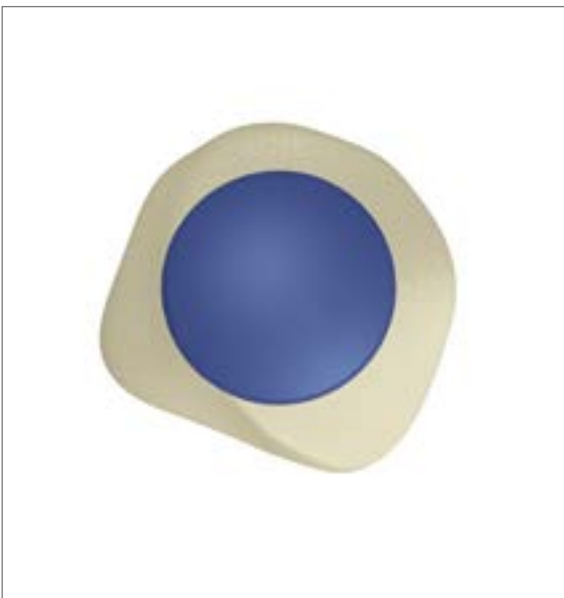

INSTRUMENTS



Patella drill/impaction clamp NS841R



Acculan drill

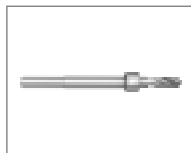

Drill with stop Ø 6 mm NQ449R



Trial patella NQ281-NQ285

- The trial femoral and tibial implants are placed onto the prepared bony surfaces.
- The polyethylene trial corresponding to the gap measurements with the spacer or the distractor is placed between both trial implants. These modular trials range in thicknesses from 10 up to 20 mm. The trials range from sizes 10 to 14 mm, with a 6 mm modular attachment to reach heights up to 20 mm.
- The trial PS peg is inserted onto the tibia through the gliding surface.
- The stability of the joint is assessed by applying varus/valgus stresses in extension and flexion. If the joint appears to be lax (opening of gaps under stress), then a thicker trial gliding surface has to be tested.

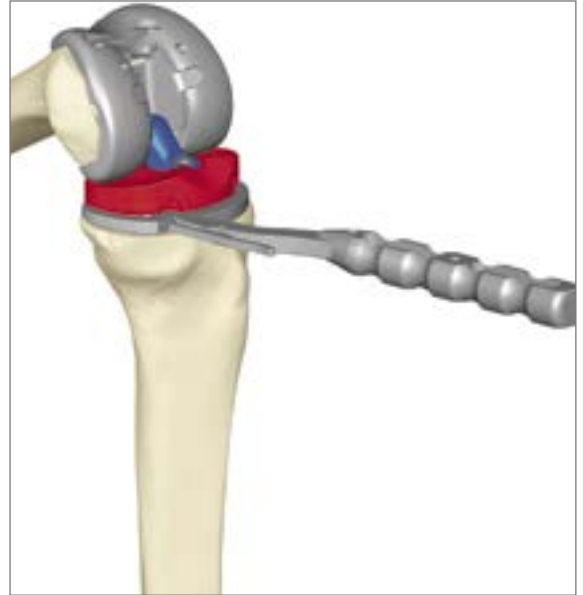

- If the medial or lateral soft tissue structures are questionable for adequate support the surgeon has the option of trialing with the PS+ peg. If this is carried out the trial box must be inserted into the femoral trial or the peg will violate the bone on the sides of the box when varus/valgus stress is applied to the knee.
- The range of motion is assessed. Intra-operative limited extension and flexion and marked hyperextension must be avoided.
- Bone residues in the dorsal region of the femur can be removed with a curved osteotome.

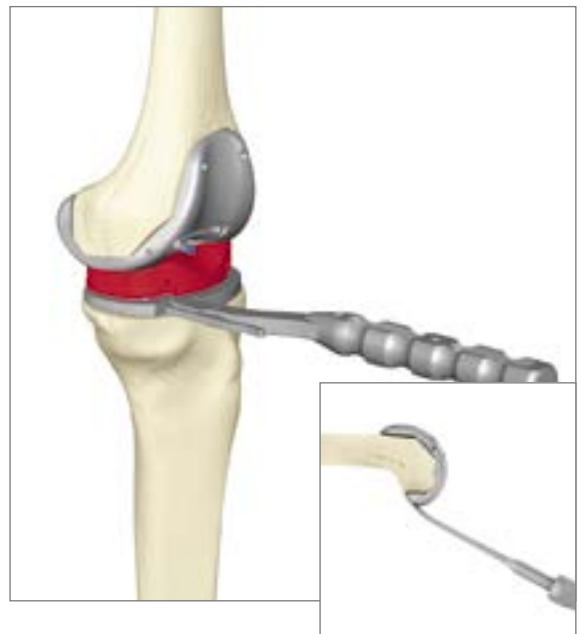

Tibia trial/preparation plateau NS349R-NS359R



Tibia trial/preparation plateau holder NQ378R



Trial gliding surface NS270-272, NS275-277, NS280-282, NS285-287, NS290-292, NS295-297



Trial spacer 6 mm NS274, NS279, NS284, NS289, NS294, NS299



Tibia PE peg NS365R, NS348R



IQ osteotome fine curved 20/205 mm NS366R



Trial femur NS301RM-NS308RM, NS311RM-NS318RM

AESCULAP® VEGA System®

14 | PREPARATION AND ASSEMBLY OF EXTENSION STEMS

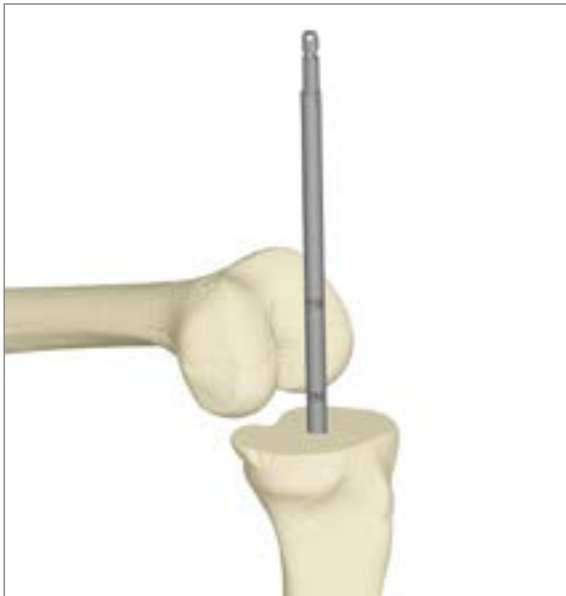

- The length that has to be prepared for implanting the cementless extension stem can be determined with the marking on the reamer. The reamer has to be inserted on the resected tibia until the marking "T92" for the short stem and "T132" for the long stem. To ensure that the final extension stem will fit a trial stem can be inserted.



- For the assembly of all extension stems (also the short extension stems NB090K/Z and NB100K/Z) on the final implant, the stems have to be tightened with a torque of 20 Nm. It is recommended to tighten the extension stem on the table and ensure that the components are hold by an assistant during tightening.

INSTRUMENTS / IMPLANTS



Tibia holder for stem torque fixation NS390R



Torque wrench NE184RM



Stem adapter for NE184RM SW 6 for extension stems Ø 12, 14 mm NE185R



Stem adapter for NE184RM SW 5 for extension stems Ø 10 mm NS835R and short tibia stem L12 mm Ø 12 mm and 14 mm



Tibia stems NB090K-NB100K, NB090Z-NB100Z, NX060K-NX065K, NX060Z-NX065Z, NX082K-NX087K, NX082Z-NX087Z



Reamer for cementless stem NS391R-NS393R

15 | COMPONENT IMPLANTATION

The following implant sequence is recommended:

- Tibia implant
- Femur implant
- Gliding surface
- Patella implant

The final tibia implant can be connected to the tibia holder / impactor and brought precisely into the predefined position. The final positioning is achieved with the help of the tibia impactor. The obturator screw diameter 12 mm fits to the tibial plateau size T0-2+. The obturator screw diameter 14 mm fits to the tibial plateau size T3-5. The obturator screw length 7 mm (NN261K/Z and NN264K/Z) has to be fixed with the stem tightening key NS378R. Alternatively the PEEK plug can be inserted in the tibial stem with the screw driver NS423R.

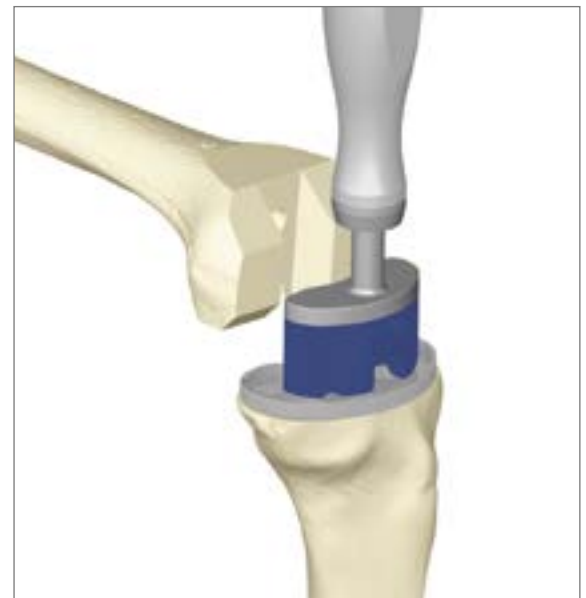
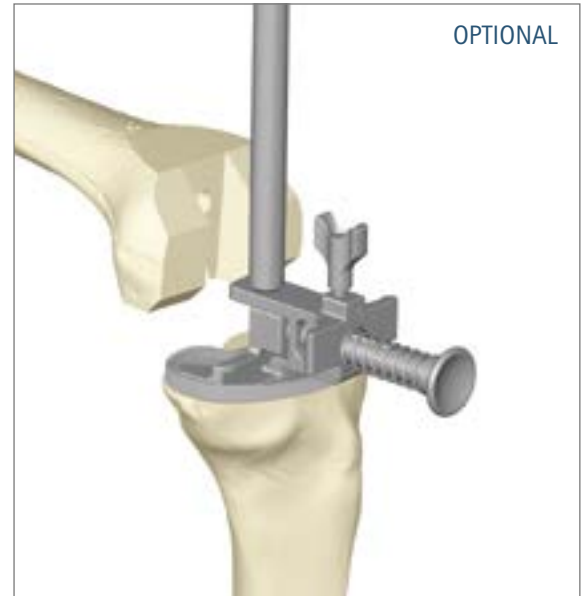

Tibia plateau holder
NS374R



Tibia plateau impac-
tor NS425



Tibia implant
NX049K-NX059K,
NX049Z-NX059Z



Obturator NN261K-
NN264K, NN261Z-
NN264Z



Stem tightening key
NS378R



PEEK plug NN260P



Screw driver SW 3.5
NS423R

AESCULAP® VEGA System®

15 | COMPONENT IMPLANTATION



- Using the femur holder and its insert, the final femur implant is brought into alignment and implanted. Care must be taken to assure the holder is properly seated and attached to the femoral implant so that it does not dislodge during cementing. A special attention has to be placed to the sagittal orientation: forcing the holder to the anterior direction helps to avoid an implantation in a flexion position.



- The femoral impactor is used to knock the implant into place.

INSTRUMENTS/IMPLANTS



Insert for NS600R,
NQ1031R-NQ1032R



Trial femur insertion
instrument NS600R



Insert for NS600R,
NQ1031R-NQ1032R



Femur impactor NS424



Femur implant
NX004K-NX018K,
NX024K-NX038K,
NX004Z-NX018Z,
NX024Z-NX038Z

NOTE

It may be prudent to use a trial insert and recheck joint motion and stability after the cement has cured before deciding on the final type and thickness of the polyethylene insert.

The PS screw will be fixed with the screw driver SW 4.5 after cement hardening. During cement curing a trial gliding surface can be inserted to avoid any movements that could cause a cement cracking.

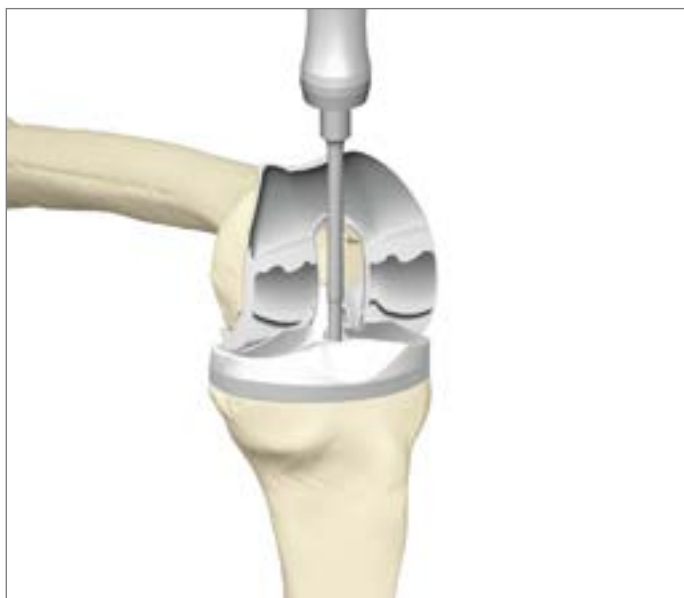

Gliding surface NX100-
NX105, NX110-NX115,
NX120-NX125, NX130-
NX135, NX140-NX145,
NX150-NX155



Patella drill/impaction
clamp NS841R



Inlay for NS841R, NS842



Patella implant NX041-
NX045

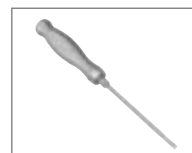

Screw driver SW 4.5
NQ660R

AESCULAP® VEGA System®

16 | CEMENTING TECHNIQUE

- Regardless of what fixation method is utilized it is critical that correct techniques are employed in order to avoid complications and early failure. Also, even with accurate cuts it is important to ensure that components are fully seated, as it is easy for this to be obscured when cementing is taking place. Varus/valgus alignment can be significantly affected by unequal medial-lateral cement mantles and poorly seated components and there can be a tendency to place femoral components in relatively flexed positions if specific care is not taken.
- It should also be noted that when definitive components are cemented in, they may prove more stable and seat better than the trials, which are often a little loose. It is therefore worthwhile to recheck the balancing and stability at this point so that further adjustments can be made if necessary. It has been possible to relate poor cementing techniques to early and continuous component migration, which in turn is of positive prognostic significance when predicting aseptic loosening so proper attention to the cementation steps must be taken.
- Preparation of the bony surfaces and cancellous bone should be performed with pulsatile type lavage with the knee under a pressure tourniquet. This step allows for well-fitting cement penetration and interlocking to the bony prepared surfaces and also removes bone debris that can serve as third body particles that increase polyethylene wear after surgery. The surfaces should be properly dried prior to cementation and appropriate exposure of all bony surfaces achieved. All of the surfaces should be pressurized for optimal cement penetration. Emphasizing the importance of effective cementation of the posterior femoral condylar surfaces is also recommended since it can have a significant effect on the longevity of the fixation of the femoral implant. A further point worth noting is that if holding the knee out in full extension while cement is hardening is used to compress components down and possibly improve cement intrusion.
- Care should be taken to completely remove all excess cement that protrudes from the implant bone interface. Any remnants of overhanging cement can impinge on surrounding soft tissue or can provide a source of debris that can serve as a generator of third body wear and may contribute to the demise of the fixation earlier than expected. Further recommendations regarding the cementation technique are summarized in the scientific information "Aesculap Implant Fixation in TKA", order number 061802.

BonOs R |
BonOs R Genta





After cement polymerization and removal of all cement excess, thoroughly irrigate the joint. If a tourniquet is used, hemostasis is achieved after its deflation.

Close soft tissue in the normal layered fashion.

AESCU LAP® VEGA System®

18 | INSTRUMENTS



NS1000 | IQ VEGA System PS BASIC INSTRUMENTATION

Item No.	Description	Container recommended	Lid	Height of tray incl. lid
NS1000	IQ VEGA System PS basic instrumentation			

Consisting of:

NQ1001	IQ Columbus/VEGA System PS set general instruments	JK444	JK489	118 mm
NQ1002	IQ Columbus/VEGA System PS set manual instruments	JK441	JK489	88 mm
NS1003	IQ VEGA System PS set femur preparation	JK440	JK489	68 mm
NS1004	IQ VEGA System PS set trial femur comp. narrow	JK444	JK489	118 mm
NS1005	IQ VEGA System PS set tibia preparation	JK444	JK489	118 mm
NS858	IQ set tibia extension stems	JK441	JK489	88 mm
NS709	IQ set patella preparation	JK441	JK489	118 mm

Instrument trays	page 55
Optional instruments	page 60
Sawblades	page 62
ELSA loaner sets	page 65

NQ1001-NQ1011R | GENERAL INSTRUMENTS

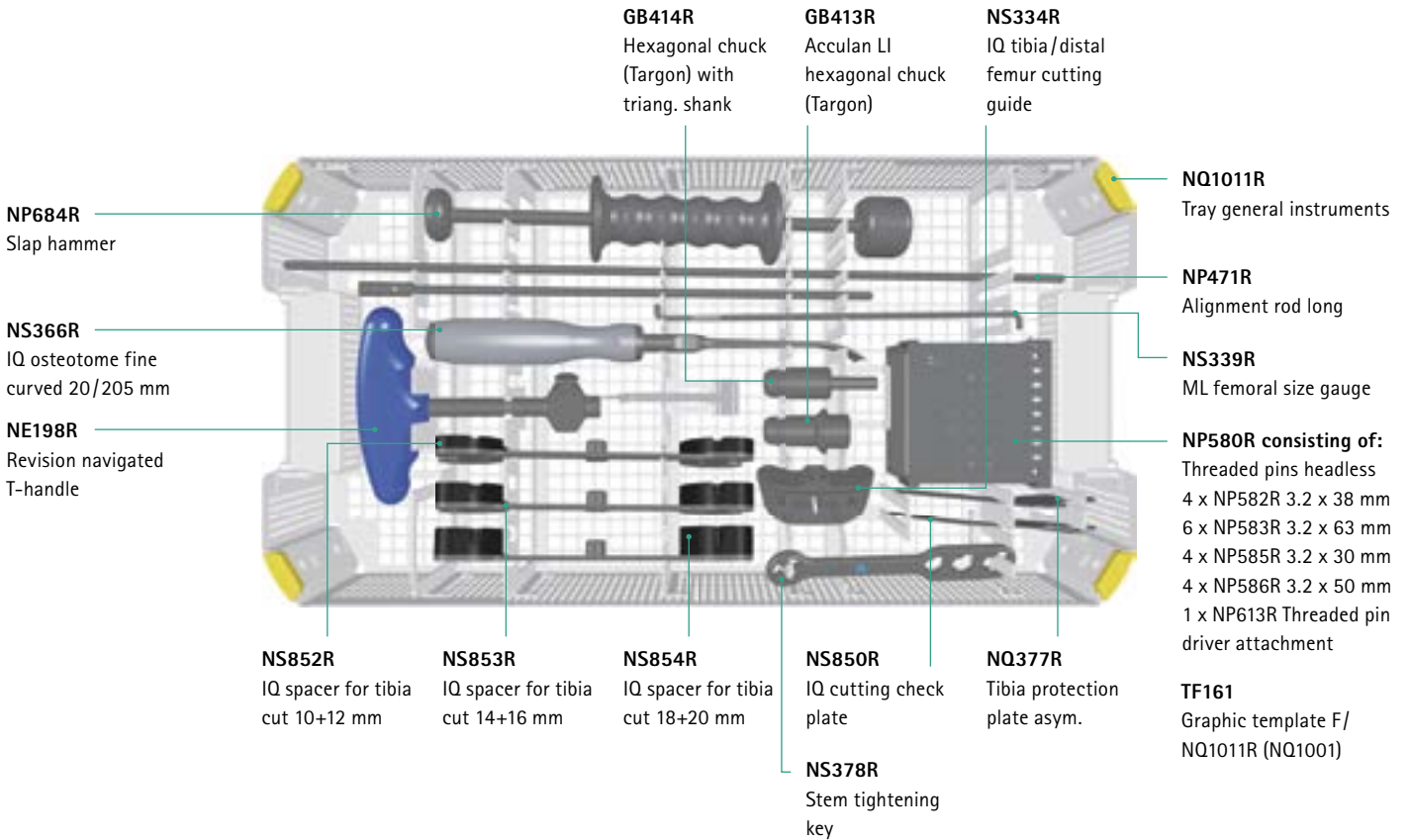

NQ1002-NQ1012R | MANUAL INSTRUMENTS

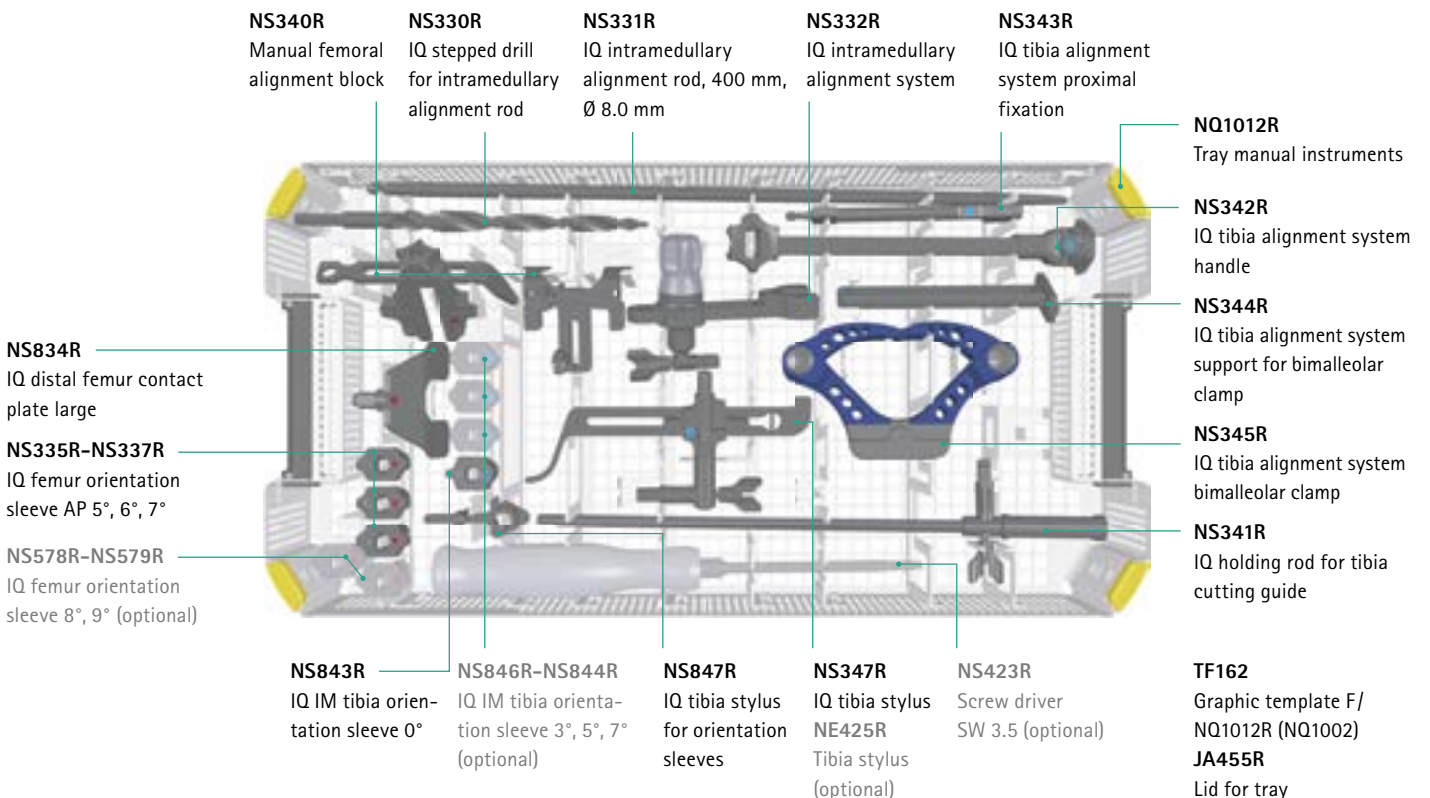

AESCU LAP® VEGA System®

NS1003-NS1006R | FEMUR PREPARATION

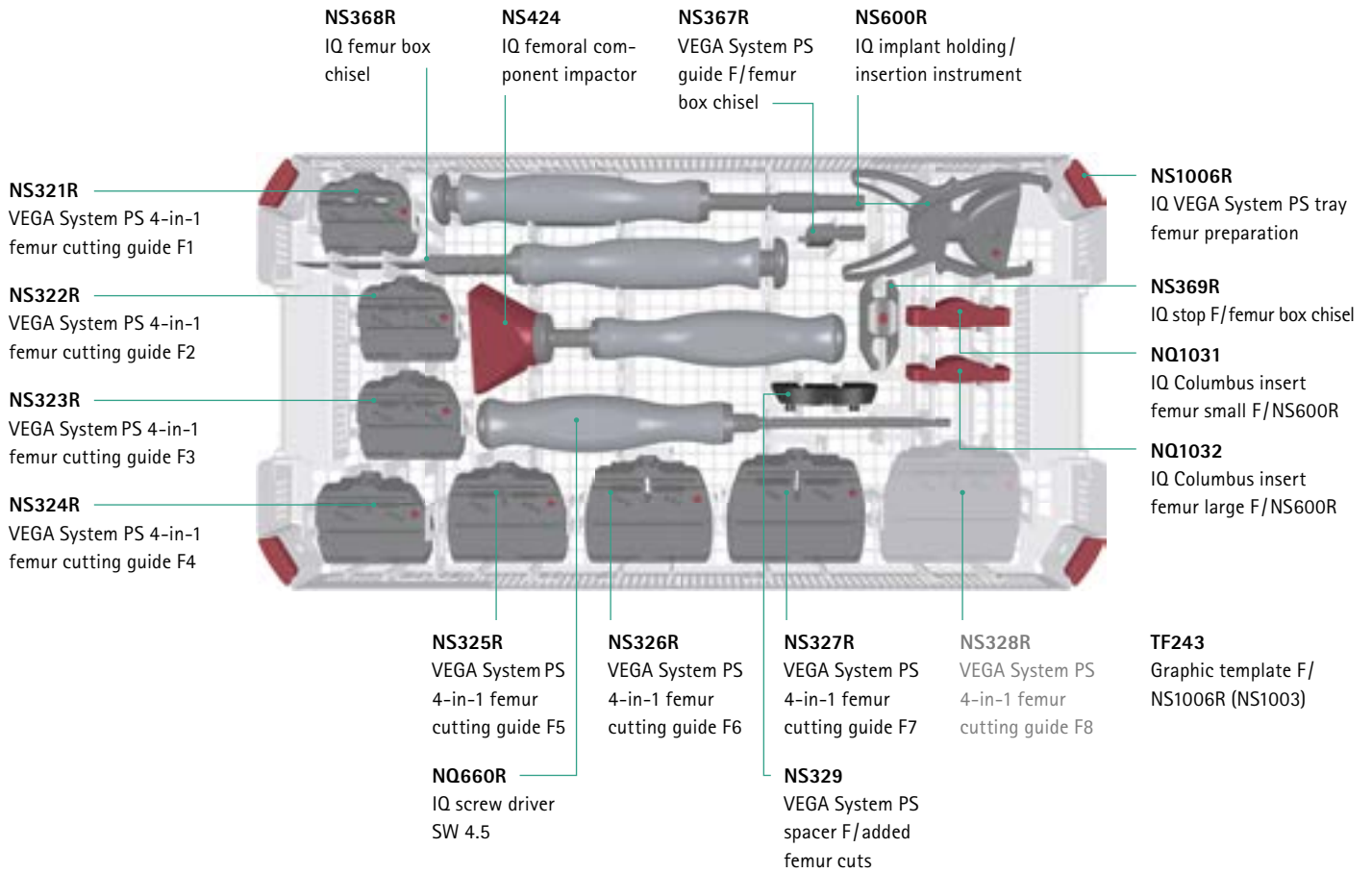

NS1004-NS1007R | FEMUR TRIAL COMPONENTS

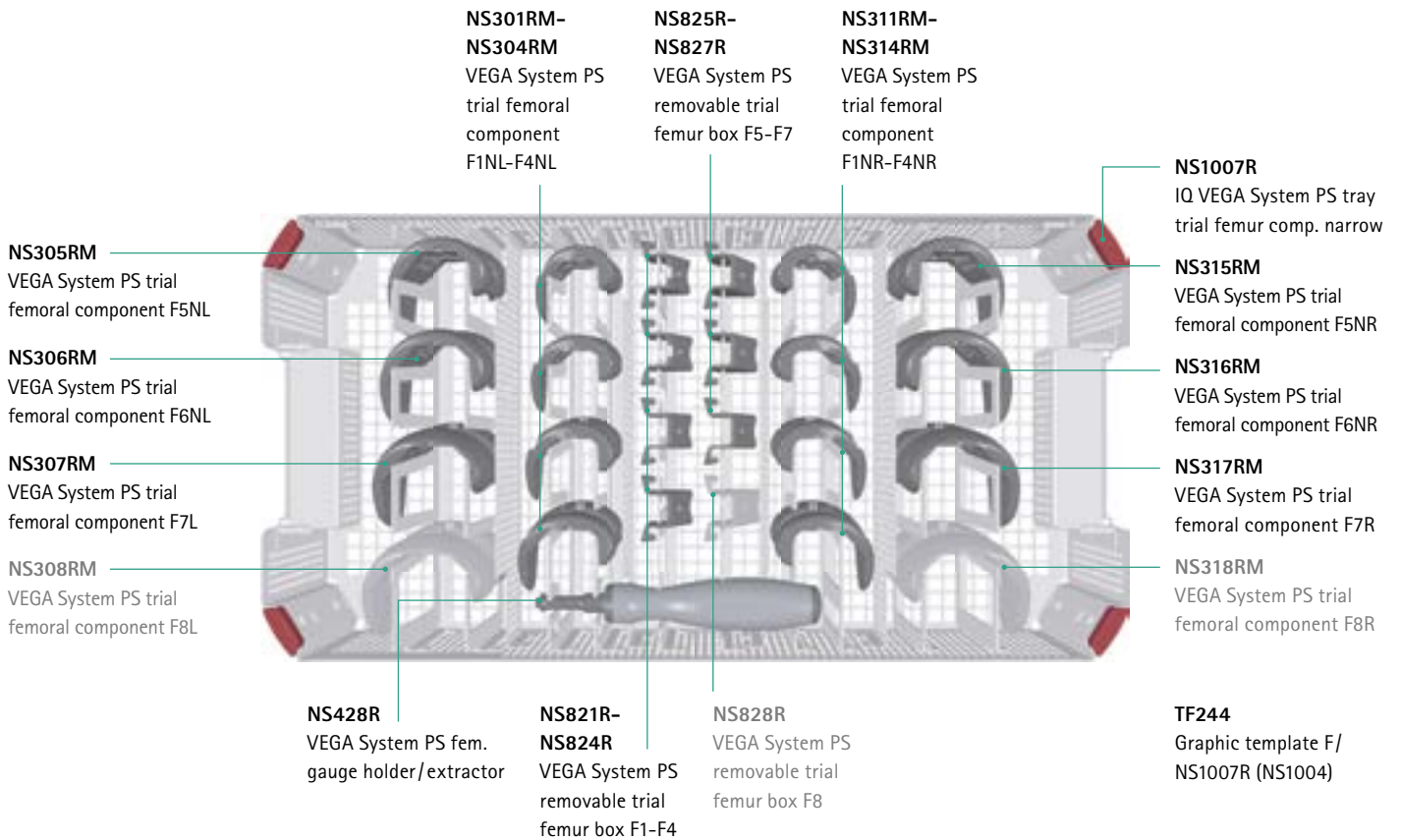

AESCULAP® VEGA System®

NS1005-NS1008R+NS1009R | TIBIA PREPARATION

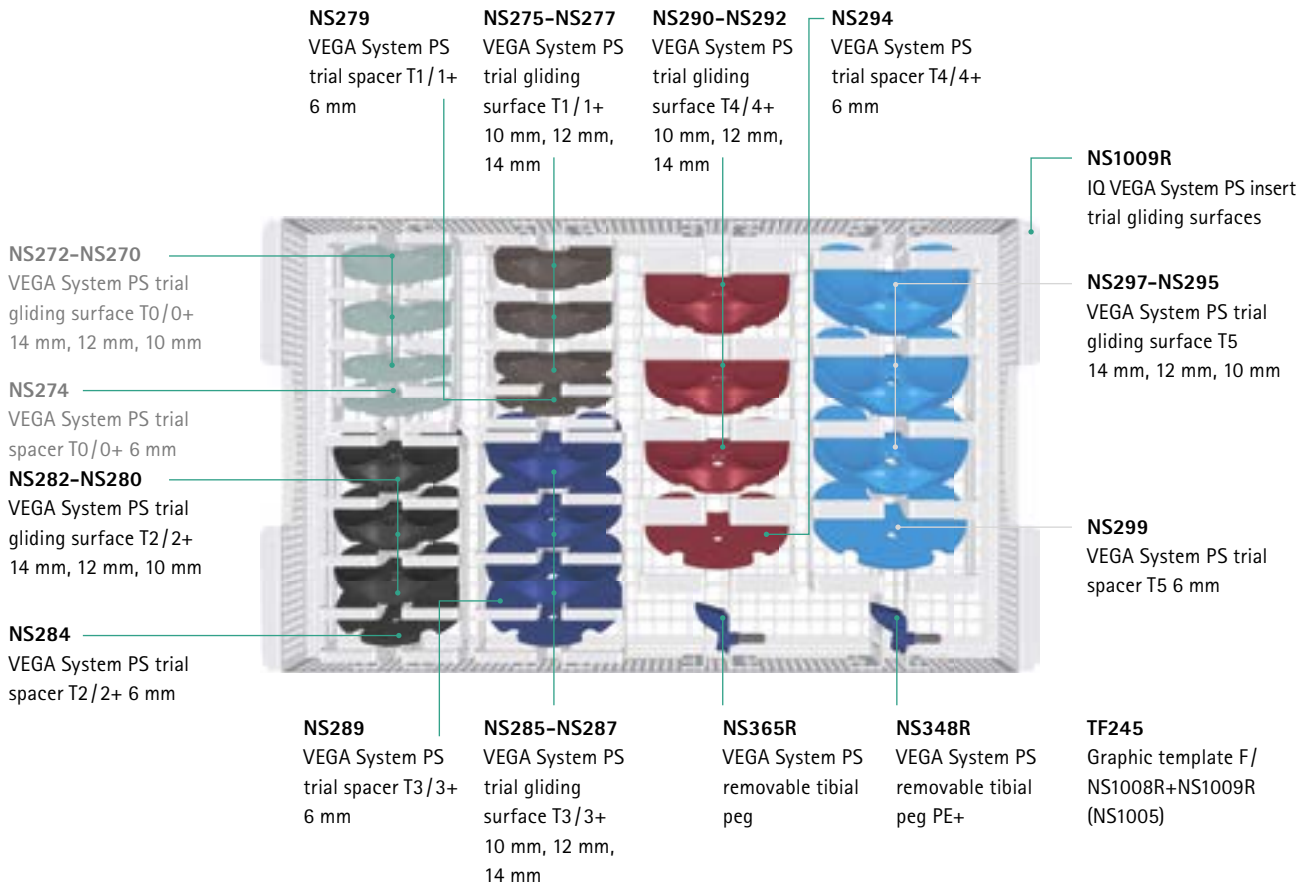
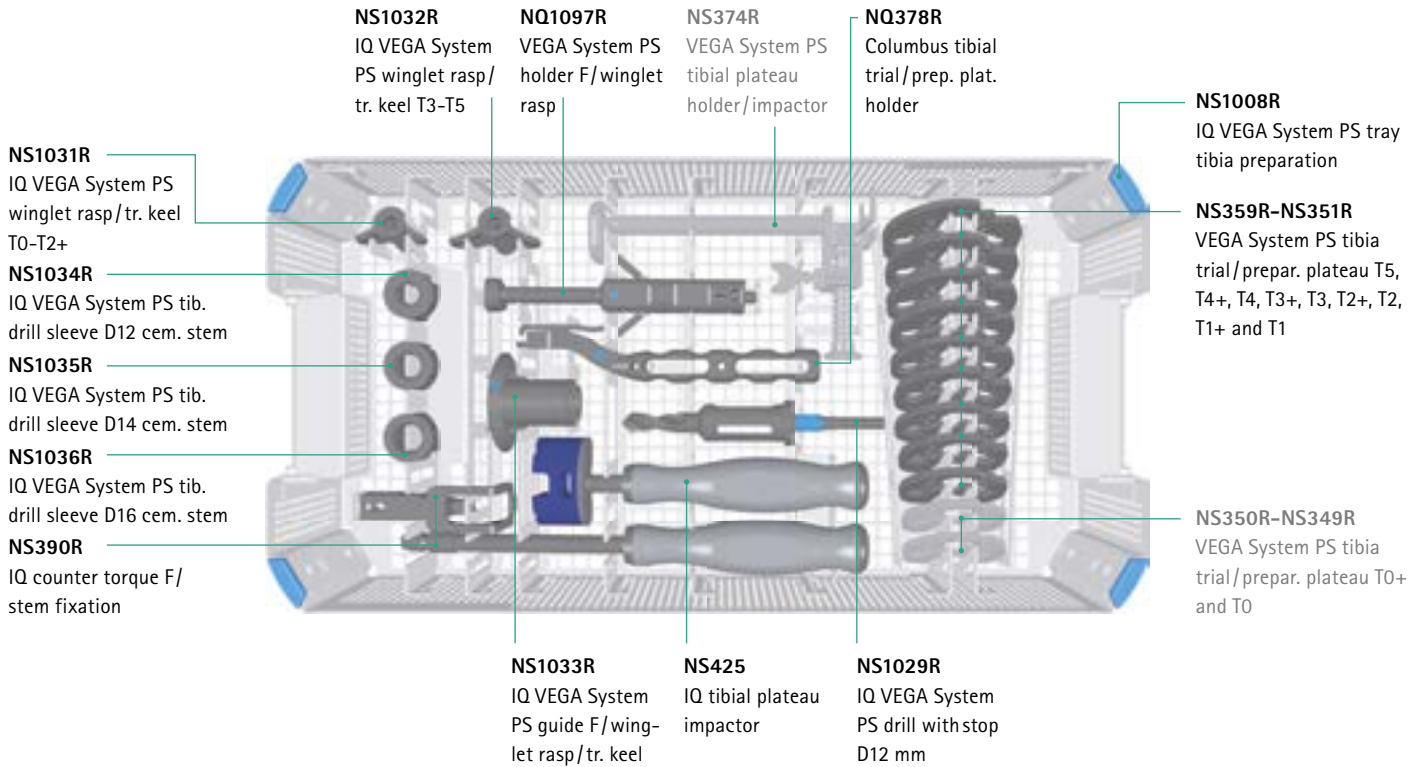

NS858+NS859R | TIBIA EXTENSION STEM

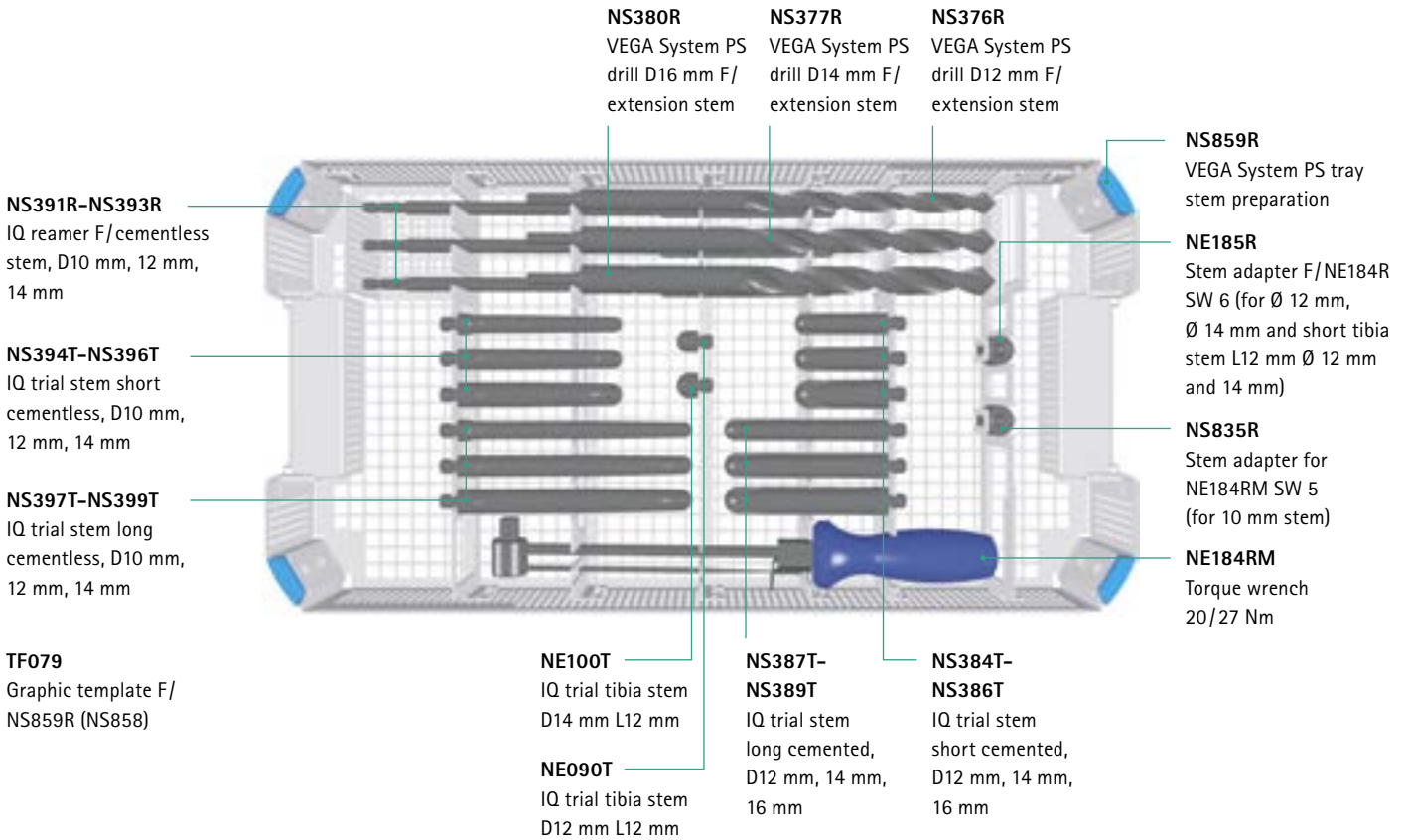

NS709+NS719R | PATELLA PREPARATION

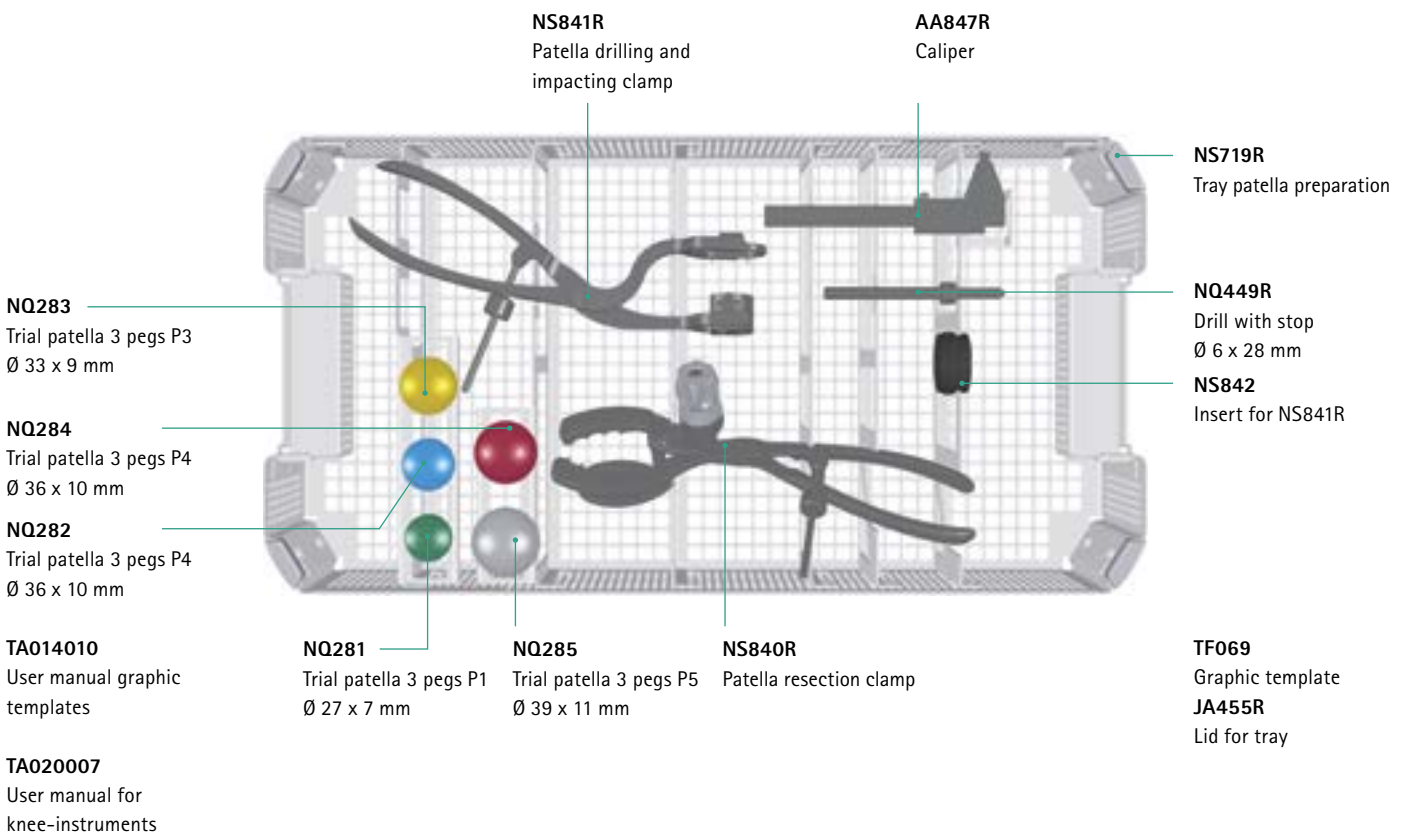

AESCULAP® VEGA System®

19 | OPTIONAL INSTRUMENTS

GENERAL



NQ414 distractor set

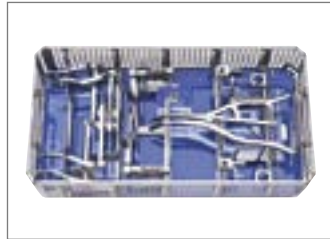

NM640 force controlled spreader set



NE150R leg positioner for TKA
NE153R fixation frame



Pin set (NP742R, NP743R,
NP748R, NP749R, NP750R)

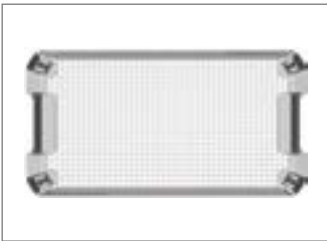

NQ1429R tray optional
instruments large

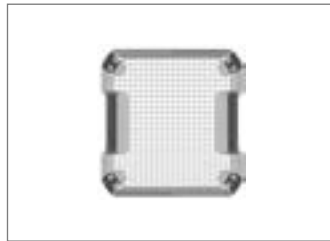

NE1029R tray optional
instruments small

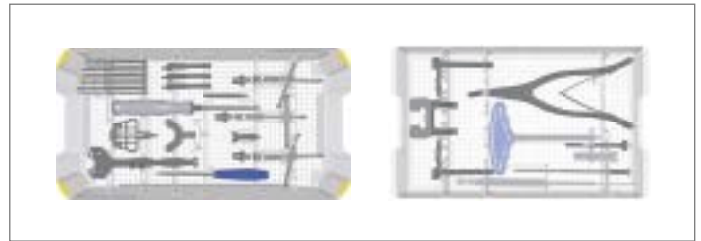

Navigation set NP138



NS863R FGT tibia EM alignment
system (storage in set NQ1002)



NE425R tibia stylus (storage in
set NQ1002)

TIBIA



NS363R obturator
12 mm



NS844R IQ tibia IM
orientation sleeve 3°



NS845R IQ tibia IM
orientation sleeve 5°



NS846R IQ tibia IM
orientation sleeve 7°



NS374R tibial plateau
holder/impactor



NS406R medialized tibia
cutting guide left



NS407R medialized tibia
cutting guide right



NS861R FGT tibial cor-
rection cutting guide 2°
var/val

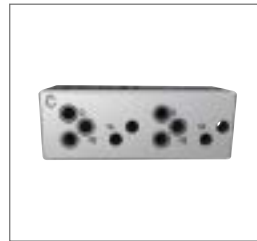

Tibia move block NQ1078R

FEMUR



NS338R posterior femur
plate neutral



NS848R posterior femur
plate 3° left



NS849R posterior femur
plate 3° right



NS371R trial femur
insertion instrument



NS837 femur insert to
NS836R



NS578R femur orienta-
tion sleeve 8°



NS579R femur orienta-
tion sleeve 9°





NS333R IQ distal femur
contact plate small



NS836R implant holding/
insertion instrument

AESCULAP® VEGA System®

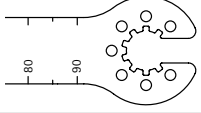
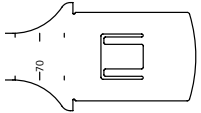
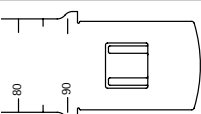
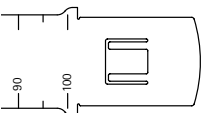
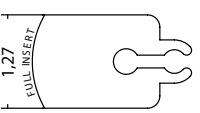
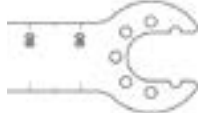
20 | SAWBLADES

System	Item No.	Width	Thickness	Sawblades 
Aesculap Comfort macro-Line Acculan 2 Length 90 mm	GE266SU	13 mm	1.27 mm	
	GE271SU	19 mm	1.27 mm	
	GE276SU	23 mm	1.27 mm	
Aesculap Acculan 3 Ti Length 75 mm	GE231SU	9 mm	1.27 mm	
Aesculap Acculan 3 Ti Length 90 mm	GE236SU	13 mm	1.27 mm	
	GE241SU	19 mm	1.27 mm	
	GE246SU	23 mm	1.27 mm	
Aesculap Acculan 3 Ti Length 100 mm	GE249SU	19 mm	1.27 mm	
Stryker System 2000, System 4-7 Length 90 mm	GE330SU	13 mm	1.27 mm	
	GE331SU	19 mm	1.27 mm	
	GE332SU	25 mm	1.27 mm	
Synthes Trauma Recon System Battery Power Line Battery Power Line II Length 90 mm	GE323SU	13 mm	1.27 mm	
	GE326SU	25 mm	1.27 mm	
Zimmer Universal Length 90 mm	GE326SU	25 mm	1.27 mm	
Conmed Linvatec/Hall Power Pro Mpower Mpower 2 Length 90 mm	GE327SU	13 mm	1.27 mm	
	GE329SU	25 mm	1.27 mm	

You will find the sawblades with Aesculap coupling in our Burrs & Blades catalog 017599.

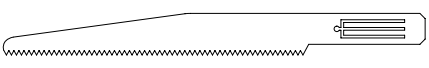
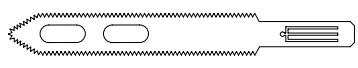
System	Sawblades for reciprocating saws 75/10/1.0/1.2 mm	Sawblade for reciprocating saws 75/12/1.0/1.2 mm
Acculan 2 Acculan 3 Ti Comfort-Line	 GC769R	 GC771R

21 | DIMENSIONS

FEMORAL COMPONENT

Dimensions in mm

Size	AP	ML	BOX
F1	50	56	32
F2N	52	56	35
F2	52	59	35
F3N	56	59	38
F3	56	63	38
F4N	60	63	42
F4	60	67	42
F5N	65	67	46
F5	65	71	46
F6N	70	71	50
F6	70	76	50
F7	76	82	55
F8	81	82	60

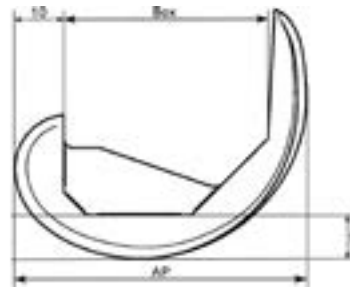

TIBIAL COMPONENT

Dimensions in mm

Size	AP	ML	Ø C
T0	41	62	12
T0+	44	62	12
T1	43	65	12
T1+	46	65	12
T2	45	70	12
T2+	49	70	12
T3	48	75	14
T3+	52	75	14
T4	51	80	14
T4+	55	80	14
T5	56	85	14

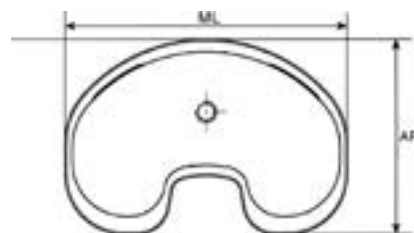
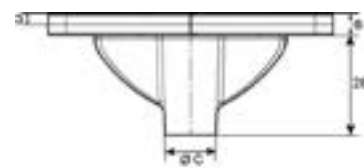

AESCULAP® VEGA System®

22 | OVERVIEW OF PATELLA SIZES

PATELLA COMPONENT

Dimensions in mm

	Patella P1	Patella P2	Patella P3	Patella 4	Patella 5
D Patella x H	D 26 x 7	D 29 x 8	D 32 x 9	D 35 x 10	D 38 x 11

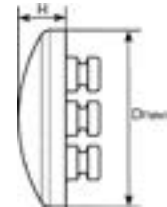

23 | OVERVIEW OF EXTENSION STEM LENGTHS

EXTENSION STEM LENGTHS

Dimensions in mm

	T0-T5
Tibia keel length	28
Tibia keel + obturator	35
Tibia keel + stem 12 mm	40
Tibia keel + stem 52 mm	80
Tibia keel + stem 92 mm	120
Tibia keel + stem 132 mm	160

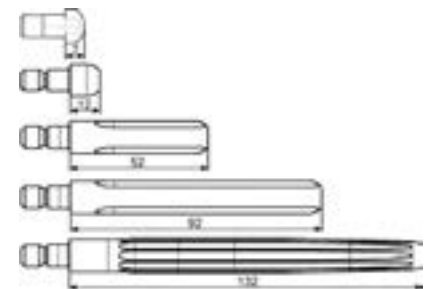

Obturator screws and 12 mm extension stems are available in diameters 12 and 14 mm.

All other extension stems are available in diameters 10, 12 and 14 mm.

24 | LOANER SETS | DEMO CASE

VEGA System LOANER SETS

Item No.	Description	Contents
LSET-K0127	VEGA System implants CoCr basis	Femur, tibia, gliding surfaces, PEEK plug, tibia obturator
LSET-K0129	VEGA System implants AS basis	AS femur, AS tibia, gliding surfaces, PEEK plug, AS tibia obturator
LSET-K0130	Patella	Patella implants, patella preparation instruments
LSET-K0212	VEGA System IQ instrument set standard	Basic instrument set
LSET-K0131	Stems CoCr	Tibia stems
LSET-K0132	Stems AS	AS tibia stems
LSET-K0149	Stem instruments	Tibia stem preparation instruments
LSET-K0134	VEGA System gliding surfaces PS+	Gliding surfaces PS+
LSET-K0051	IQ navigation set	Navigation instrument set
LSET-K0213	VEGA System IQ instrument set Aesculap RESET	Instrument set Aesculap RESET

X-RAY TEMPLATES

Item No.	Description
NS426	VEGA System X-ray templates set 1.1:1
NS427	VEGA System X-ray templates set 1.15:1

FEMUR CEMENTED



Types:	F1	F2N	F2	F3N	F3	F4N	F4	F5N	F5	F6N
Left CoCr	NX004K	NX005K	NX006K	NX007K	NX008K	NX009K	NX010K	NX011K	NX012K	NX013K
Left AS	NX004Z	NX005Z	NX006Z	NX007Z	NX008Z	NX009Z	NX010Z	NX011Z	NX012Z	NX013Z
Right CoCr	NX024K	NX025K	NX026K	NX027K	NX028K	NX029K	NX030K	NX031K	NX032K	NX033K
Right AS	NX024Z	NX025Z	NX026Z	NX027Z	NX028Z	NX029Z	NX030Z	NX031Z	NX032Z	NX033Z



Types:	F6	F7	F8
Left CoCr	NX014K	NX016K	NX018K
Left AS	NX014Z	NX016Z	NX018Z
Right CoCr	NX034K	NX036K	NX038K
Right AS	NX034Z	NX036Z	NX038Z

PATELLA 3-PEG



Types:	F1-F8
P1	NX041
P2	NX042
P3	NX043
P4	NX044
P5	NX045

IMPLANT MATERIALS

ISODUR _C	Casted cobalt-chrome alloy (CoCrMo/ISO 5832-4)
ISODUR _F	Forged cobalt-chrome alloy (CoCrMo/ISO 5832-12)
UHMWPE	Ultra High Molecular Weight Polyethylene (ISO 5834-2)

CHART FEMUR/TIBIA SIZE COMPATIBILITY

Sizes	F1	F2/F2N	F3/F3N	F4/F4N	F5/F5N	F6/F6N	F7	F8
T0/T0+	Green	Green	Green	Yellow	Red	Red	Red	Red
T1/T1+	Green	Green	Green	Green	Yellow	Red	Red	Red
T2/T2+	Yellow	Green	Green	Green	Green	Yellow	Red	Red
T3/T3+	Red	Yellow	Green	Green	Green	Green	Yellow	Red
T4/T4+	Red	Red	Yellow	Green	Green	Green	Green	Red
T5	Red	Red	Red	Yellow	Green	Green	Green	Green

- Ideal combination
- Possible combination
- Combination not allowed

STANDARD AND NARROW (N) SIZES OF THE VEGA System FEMUR COMPONENTS

Measurements	ML F1	ML F2	ML F3	ML F4	ML F5	ML F6	ML F7
AP F1	F1						
AP F2	F2N	F2					
AP F3		F3N	F3				
AP F4			F4N	F4			
AP F5				F5N	F5		
AP F6					F6N	F6	
AP F7							F7
AP F8							F8

VEGA System IMPLANT MATRIX – TIBIAL PARTS

TIBIA CEMENTED



Types:	T0	T0+	T1	T1+	T2	T2+	T3	T3+	T4	T4+	T5
CoCr	NX049K	NX050K	NX051K	NX052K	NX053K	NX054K	NX055K	NX056K	NX057K	NX058K	NX059K
AS	NX049Z	NX050Z	NX051Z	NX052Z	NX053Z	NX054Z	NX055Z	NX056Z	NX057Z	NX058Z	NX059Z

OBTURATOR



Types:	Ø 12 mm	Ø 14 mm
T0-T2+ CoCr	NN261K	
T0-T2+ AS	NN261Z	
T3-T5 CoCr		NN264K
T3-T5 AS		NN264Z

PEEK PLUG



Types:	Ø 14 mm
T0-T5	NN260P

TIBIA STEMS CEMENTED



Types:	Ø 10 mm		Ø 12 mm		Ø 14 mm	
	52 mm	92 mm	52 mm	92 mm	52 mm	92 mm
T0-T5 CoCr	NX060K	NX061K	NX062K	NX064K	NX063K	NX065K
T0-T5 AS	NX060Z	NX061Z	NX062Z	NX064Z	NX063Z	NX065Z

TIBIA STEMS CEMENTLESS



Types:	Ø 10 mm		Ø 12 mm		Ø 14 mm	
	92 mm	132 mm	92 mm	132 mm	92 mm	132 mm
T0-T5 CoCr	NX082K	NX083K	NX084K	NX086K	NX085K	NX087K
T0-T5 AS	NX082Z	NX083Z	NX084Z	NX086Z	NX085Z	NX087Z

TIBIA STEMS SHORT



Types:	Ø 12 mm	Ø 14 mm
	12 mm	12 mm
T0-T5 CoCr	NB090K	NB100K
T0-T5 AS	NB090Z	NB100Z

PS GLIDING SURFACE



Types:	10 mm	12 mm	14 mm	16 mm	18 mm	20 mm
T0/T0+	NX100	NX101	NX102	NX103	NX104	NX105
T1/T1+	NX110	NX111	NX112	NX113	NX114	NX115
T2/T2+	NX120	NX121	NX122	NX123	NX124	NX125
T3/T3+	NX130	NX131	NX132	NX133	NX134	NX135
T4/T4+	NX140	NX141	NX142	NX143	NX144	NX145
T5	NX150	NX151	NX152	NX153	NX154	NX155

PS+ GLIDING SURFACE



Types:	10 mm	12 mm	14 mm	16 mm	18 mm	20 mm
T0/T0+	NX200	NX201	NX202	NX203	NX204	NX205
T1/T1+	NX210	NX211	NX212	NX213	NX214	NX215
T2/T2+	NX220	NX221	NX222	NX223	NX224	NX225
T3/T3+	NX230	NX231	NX232	NX233	NX234	NX235
T4/T4+	NX240	NX241	NX242	NX243	NX244	NX245
T5	NX250	NX251	NX252	NX253	NX254	NX255

AESCULAP® VEGA System®

26 | LITERATURE

¹ Scuderi GR, Tenholder M, Capeci C. Surgical approaches in mini-incision total knee arthroplasty. Clin Orthop Relat Res. 2004 Nov;(428):61-7. Review.

² Aglietti P, Baldini A, Sensi L. Quadriceps-sparing versus mini-subvastus approach in total knee arthroplasty. Clin Orthop Relat Res. 2006 Nov;452:106-11.

A series of horizontal dotted lines for writing.

AESCULAP® – a B. Braun brand

Aesculap AG | Am Aesculap-Platz | 78532 Tuttlingen | Germany
Phone +49 7461 95-0 | Fax +49 7461 95-2600 | www.aesculap.com

The main product trademark "Aesculap" and the product trademarks "Aesculap OrthoTray", "Aesculap RESET", "Columbus", "ISODUR", "OrthoPilot", "Targon" and "VEGA System" are registered trademarks of Aesculap AG. "BonOs" is a registered trademark of aap Biomaterials GmbH.

Subject to technical changes. All rights reserved. This brochure may only be used for the exclusive purpose of obtaining information about our products. Reproduction in any form partial or otherwise is not permitted.